

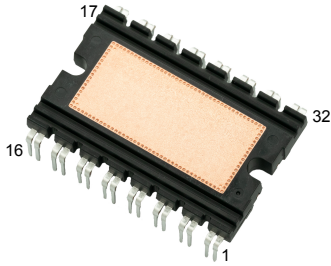

Automotive-grade ACEPACK DMT-32 power module, fourpack topology, 1200 V, 47.5 mΩ typ. SiC Power MOSFET with NTC



ACEPACK DMT-32

Features

- AQC 324 qualified 
- 1200 V blocking voltage
- 47.5 mΩ of typical $R_{DS(on)}$
- Maximum operating junction temperature $T_J = 175\text{ °C}$
- DBC Cu-AlN-Cu based substrate to improve thermal performance
- Insulation voltage 3 kV
- Integrated NTC temperature sensor

Applications

- On board charger (OBC)

Description

This ACEPACK DMT-32 power module realizes a fourpack topology with integrated NTC, tailored for the DC/DC converter stage of the OBC in hybrid and electric vehicles. The power module features four silicon carbide Power MOSFETs of 3rd generation from STMicroelectronics. Thanks to the well-recognized chip technology, the ACEPACK DMT-32 ensures the best compromise between energy losses and high switching frequency operation mode. This module allows you to create complex topologies with very high power densities as well as high efficiency requirements. The AlN insulated substrate enables optimal thermal performance. Moreover, thanks to the specific design featuring grooves on the molding ensure a high creepage distance.

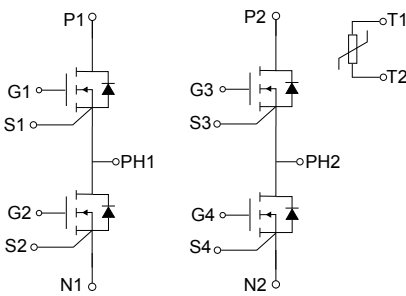

Product status link

[M1F45M12W2-1LA](#)

Product summary

Order code	M1F45M12W2-1LA
Marking	M1F45M12W2-1LA
Package	ACEPACK DMT-32
Packing	Tube

1 Inverter switch

Table 1. Absolute maximum ratings

Symbol	Parameter	Value	Unit
V_{DS}	Drain-source breakdown voltage	1200	V
V_{GS}	Gate-source voltage	-10 to 22	V
	Gate-source voltage (recommended operating values)	-5 to 18	
I_D	Drain current (continuous) at $T_C = 50\text{ °C}$	30	A
$I_{DM}^{(1)}$	Drain current (pulsed, $t_p = 1\text{ ms}$)	95	A
T_J	Operating junction temperature range	-40 to 175	°C

1. Pulse width is limited by safe operating area.

Table 2. Electrical characteristics - SiC MOSFET

Symbol	Parameter	Test conditions	Min.	Typ.	Max.	Unit
$V_{(BR)DSS}$	Drain-source breakdown voltage	$V_{GS} = 0\text{ V}, I_D = 1\text{ mA}$	1200			V
$R_{DS(on)}$	Static drain-source on resistance	$V_{GS} = 18\text{ V}, I_D = 20\text{ A}$		47.5	64	mΩ
		$V_{GS} = 18\text{ V}, I_D = 20\text{ A}, T_J = 175\text{ °C}$		101		
$V_{GS(th)}$	Gate threshold voltage	$V_{DS} = V_{GS}, I_D = 1\text{ mA}$	1.9	3.1	5	V
I_{DSS}	Zero gate voltage drain current	$V_{GS} = 0\text{ V}, V_{DS} = 1200\text{ V}$			10	μA
I_{GSS}	Gate-body leakage current	$V_{DS} = 0\text{ V}, V_{GS} = -10\text{ to }22\text{ V}$			±100	nA
C_{iss}	Input capacitance	$V_{DS} = 800\text{ V}, f = 1\text{ MHz}, V_{GS} = 0\text{ V}$		2086		pF
C_{oss}	Output capacitance			90		pF
C_{rss}	Reverse transfer capacitance			18		pF
R_G	Intrinsic gate resistance	$f = 1\text{ MHz open drain}$		1		Ω
Q_g	Total gate charge	$V_{DD} = 800\text{ V}, I_D = 25\text{ A},$ $V_{GS} = -5\text{ to }18\text{ V}$		100		nC
Q_{gs}	Gate-source charge			22.4		nC
Q_{gd}	Gate-drain charge			60.7		nC
E_{on}	Turn-on switching energy	$V_{DS} = 800\text{ V}, I_D = 25\text{ A}, V_{GS} = -5\text{ to }18\text{ V},$		547		μJ
E_{off}	Turn-off switching energy	$R_{G(on)} = 12\text{ Ω}, R_{G(off)} = 4.7\text{ Ω}$		91		μJ
E_{on}	Turn-on switching energy	$V_{DS} = 800\text{ V}, I_D = 25\text{ A}, V_{GS} = -5\text{ to }18\text{ V},$		733		μJ
E_{off}	Turn-off switching energy	$R_{G(on)} = 12\text{ Ω}, R_{G(off)} = 4.7\text{ Ω}, T_J = 175\text{ °C}$		97		μJ
R_{thJC}	Thermal resistance, junction-to-case			0.38		°C/W

Table 3. Reverse intrinsic SiC diode characteristics

Symbol	Parameter	Test conditions	Min.	Typ.	Max.	Unit
V_{SD}	Forward on voltage drop	$V_{GS} = 0\text{ V}$, $I_{SD} = 20\text{ A}$	-	2.5	-	V
t_{rr}	Reverse recovery time	$I_{SD} = 25\text{ A}$, $V_{DD} = 800\text{ V}$,	-	13.5	-	ns
Q_{rr}	Reverse recovery charge	$di/dt_{on} = 2000\text{ A}/\mu\text{s}$, $V_{GS} = -5\text{ to }18\text{ V}$,	-	189	-	nC
I_{RRM}	Reverse recovery current	$R_G = 12\ \Omega$	-	24.4	-	A
t_{rr}	Reverse recovery time	$I_{SD} = 25\text{ A}$, $V_{DD} = 800\text{ V}$,	-	31	-	ns
Q_{rr}	Reverse recovery charge	$di/dt_{on} = 2000\text{ A}/\mu\text{s}$, $V_{GS} = -5\text{ to }18\text{ V}$,	-	574	-	nC
I_{RRM}	Reverse recovery current	$R_G = 12\ \Omega$, $T_J = 175\text{ }^\circ\text{C}$	-	32	-	A

2 NTC

Table 4. Absolute maximum ratings for NTC temperature sensor, considered as stand-alone

Symbol	Parameter	Test conditions	Min.	Typ.	Max.	Unit
R_{25}	Resistance rating	T = 25 °C		10		k Ω
$\Delta R_{25}/R$	Resistance tolerance		-2		+2	%
R_{100}	Resistance rating	T = 100 °C		674.8		Ω
$\Delta R_{100}/R$	Resistance tolerance		-4.75		4.75	%
$R_{25/50}$	B-value	T = 25 °C to 50 °C		3940		K
$R_{25/85}$		T = 25 °C to 85 °C		3980		
$R_{25/100}$		T = 25 °C to 100 °C ($\pm 1\%$)		4000		
T	Operating temperature range		-40		150	°C

3 Electrical topology and pin description

Figure 1. ACEPACK DMT-32 pin layout (bottom view)

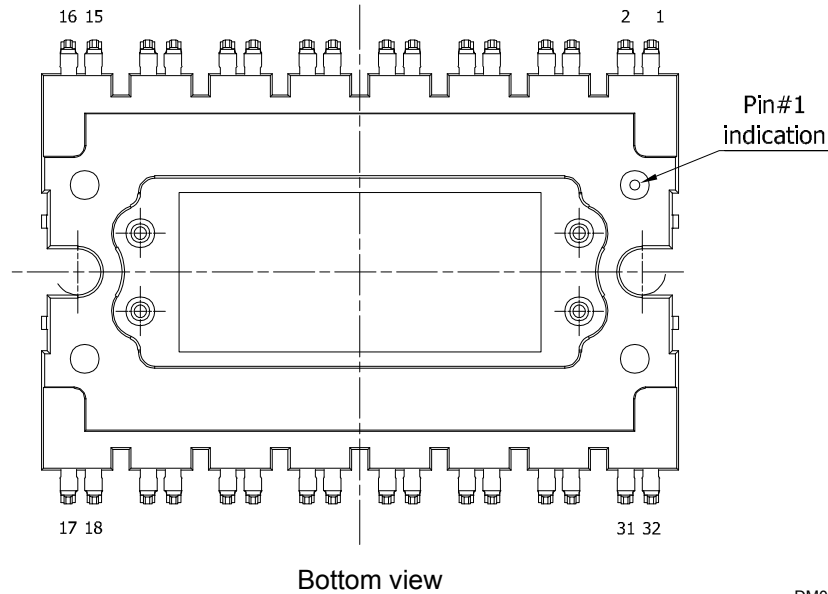

DM00692330_rev_5_pin_layout

Table 5. Pin description

Pin	Description	Pin	Description
1	NC	17	NC
2	NC	18	NC
3	N1	19	P2
4	N1	20	P2
5	S2	21	NC
6	G2	22	G3
7	PH1	23	S3
8	PH1	24	NC
9	NC	25	PH2
10	S1	26	PH2
11	G1	27	G4
12	NC	28	S4
13	P1	29	N2
14	P1	30	N2
15	NC	31	T1 (NTC)
16	NC	32	T2 (NTC)

Figure 2. Electrical topology and pin description

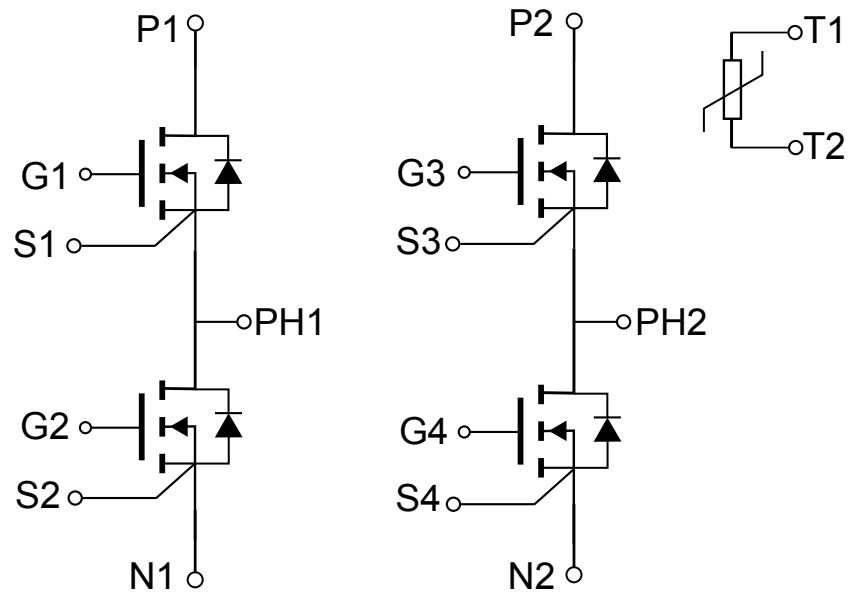

4 Electrical characteristics (curves)

Figure 3. Typical output characteristics ($T_J = -40\text{ }^\circ\text{C}$)

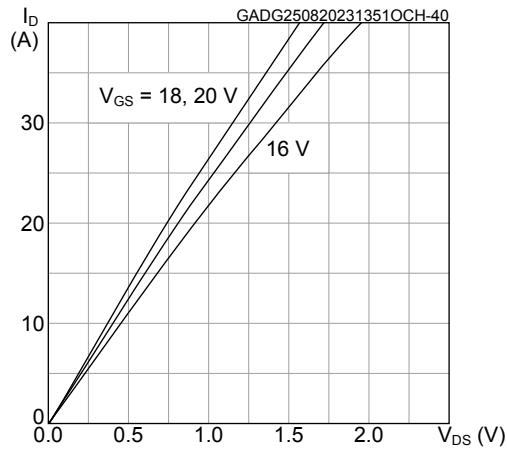

Figure 4. Typical output characteristics ($T_J = 25\text{ }^\circ\text{C}$)

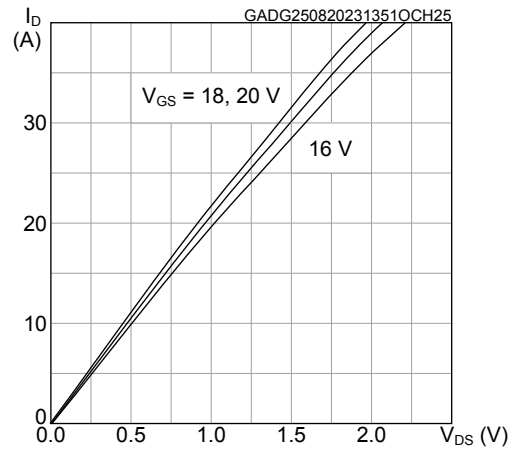

Figure 5. Typical output characteristics ($T_J = 175\text{ }^\circ\text{C}$)

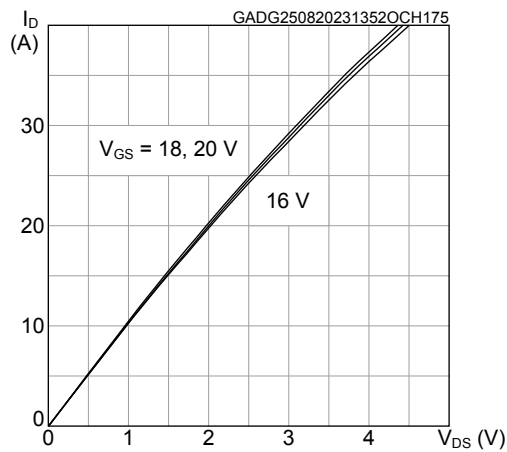

Figure 6. Typical transfer characteristics

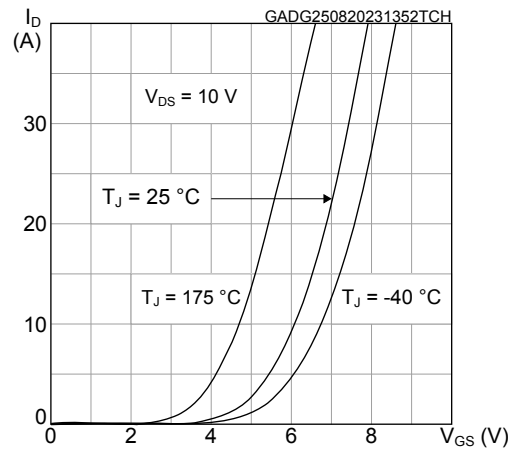

Figure 7. Typical reverse conduction characteristics ($T_J = -40\text{ }^\circ\text{C}$)

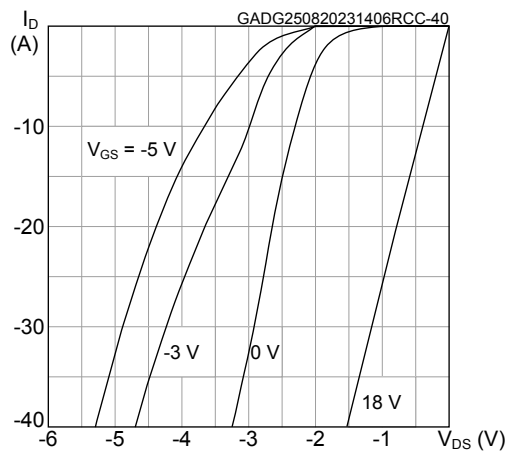

Figure 8. Typical reverse conduction characteristics ($T_J = 25\text{ }^\circ\text{C}$)

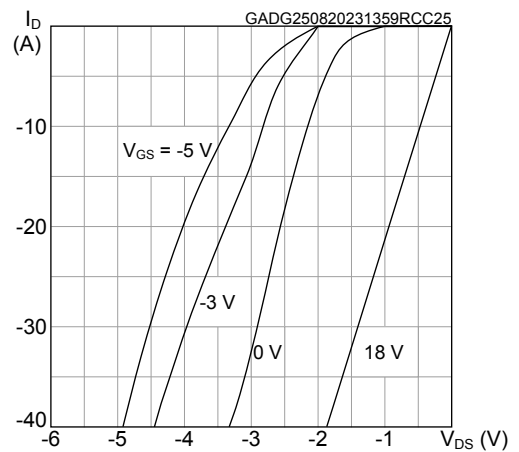

Figure 9. Typical reverse conduction characteristics
($T_J = 175\text{ }^\circ\text{C}$)

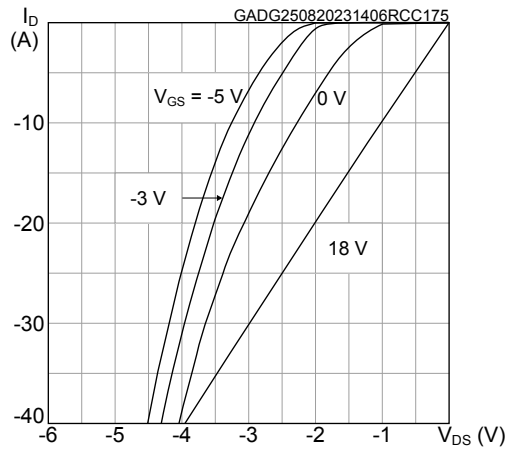

Figure 10. Typical switching energy vs temperature

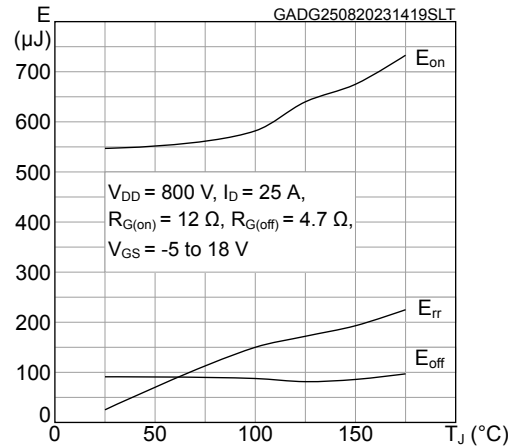

Figure 11. Typical switching energy vs drain current
($T_J = 25\text{ }^\circ\text{C}$)

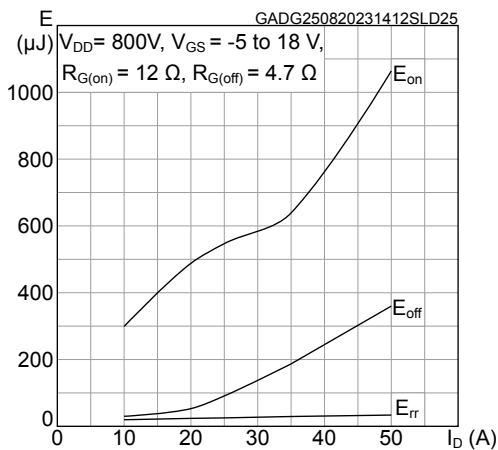

Figure 12. Typical switching energy vs drain current
($T_J = 175\text{ }^\circ\text{C}$)

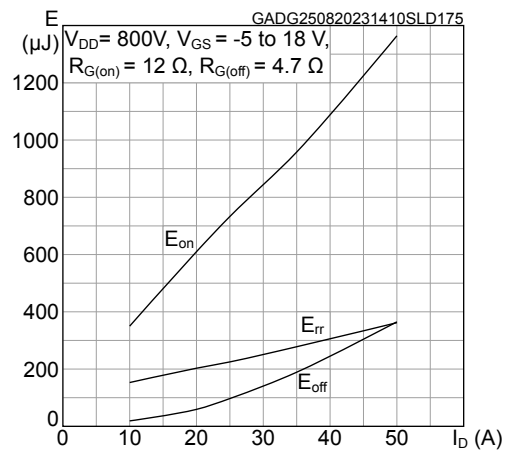

Figure 13. Typical switching energy vs gate resistance
($T_J = 25\text{ }^\circ\text{C}$)

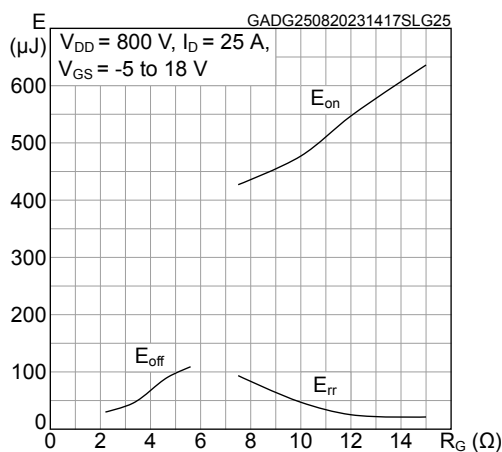

Figure 14. Typical switching energy vs gate resistance
($T_J = 175\text{ }^\circ\text{C}$)

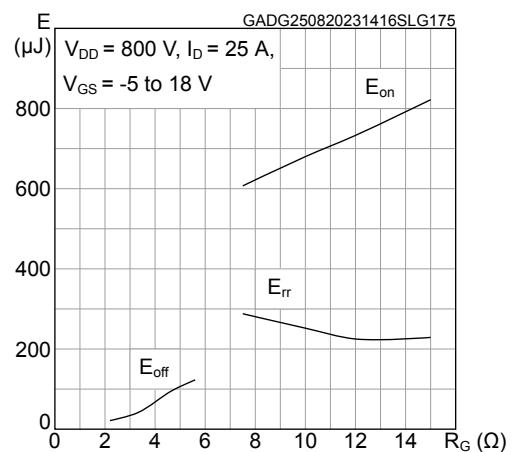

Figure 15. Typical switching energy vs bus voltage
($T_J = 25\text{ }^\circ\text{C}$)

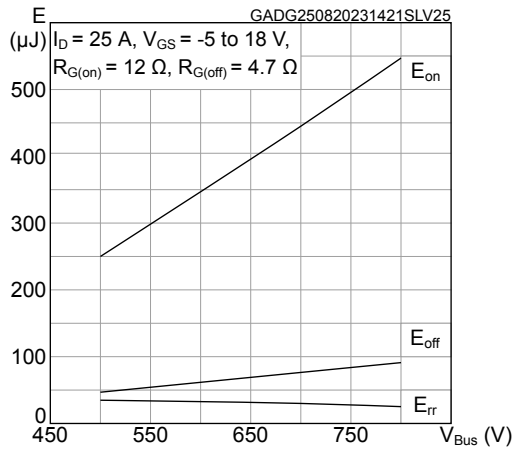

Figure 16. Typical switching energy vs bus voltage
($T_J = 175\text{ }^\circ\text{C}$)

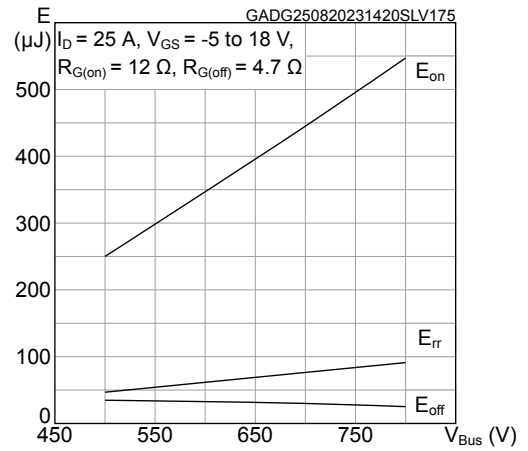

Figure 17. Typical gate charge characteristics

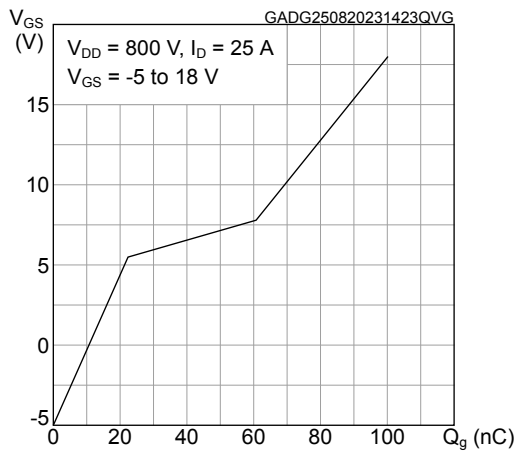
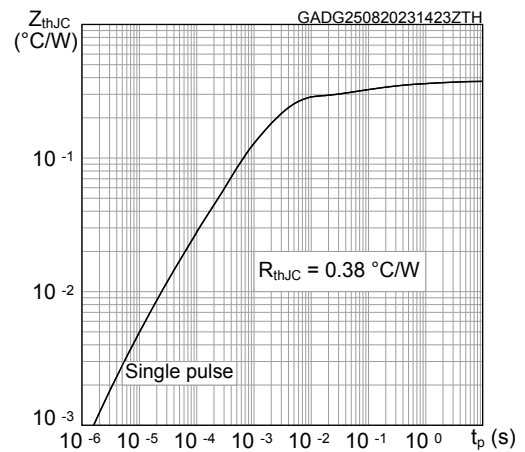

Figure 18. Typical transient thermal impedance



5 Package information

In order to meet environmental requirements, ST offers these devices in different grades of **ECOPACK** packages, depending on their level of environmental compliance. ECOPACK specifications, grade definitions and product status are available at: www.st.com. ECOPACK is an ST trademark.

5.1 ACEPACK DMT-32 package information

Figure 19. ACEPACK DMT-32 package outline

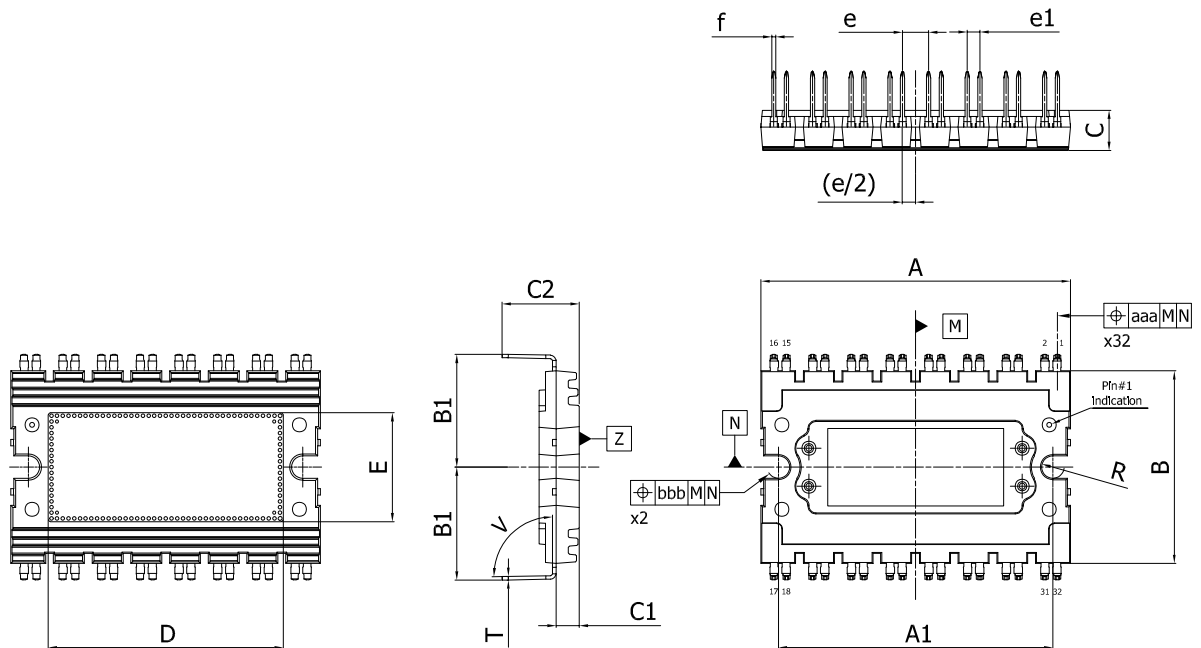

DM00692330_5

Table 6. ACEPACK DMT-32 package mechanical data

Dim.	mm		
	Min.	Typ.	Max.
A	43.50	44.00	44.50
A1	38.80	39.00	39.20
B	26.90	27.40	27.90
B1	15.90	16.05	16.20
C	5.50	5.70	5.90
C1	3.15	3.30	3.45
C2	10.85	11.00	11.15
e	3.50	3.70	3.90
e1	1.60	1.80	2.00
D	33.00	33.40	33.80
E	15.10	15.50	15.90
f	0.60	0.65	0.70
R	1.60		1.70
T	0.48	0.53	0.58
V	90°		93°
aaa		0.30	
bbb		0.15	

Table 7. Ratings for module

Symbol	Parameter	Value	Unit
V _{ISO}	Isolation voltage (f = 50 Hz, t = 60 s)	3	kV
CTI	Comparative tracking index	600	V
T _{stg}	Storage temperature range	-40 to 150	°C

Revision history

Table 8. Document revision history

Date	Revision	Changes
08-Mar-2022	1	First release.
19-Apr-2022	2	Updated <i>Table 2. Electrical characteristics - SiC MOSFET.</i>
09-Nov-2022	3	Updated <i>Table 2. Electrical characteristics - SiC MOSFET.</i> Updated <i>Table 3. Reverse intrinsic SiC diode characteristics.</i>
01-Sep-2023	4	Updated title, <i>Cover image, Features and Description</i> on cover page. Updated <i>Section 1 Inverter switch.</i> Added <i>Section 4 Electrical characteristics (curves)</i> Updated <i>Section 5 Package information.</i> Minor text changes.
07-Sep-2023	5	Updated <i>Features</i> on cover page. Updated <i>Table 4. Absolute maximum ratings for NTC temperature sensor, considered as stand-alone.</i> .
20-Sep-2023	6	Updated <i>Schematic and Applications</i> on cover page. Updated <i>Table 2. Electrical characteristics - SiC MOSFET and Section 3 Electrical topology and pin description.</i>
06-Oct-2023	7	Updated <i>Schematic and Description</i> on cover page. Updated <i>Section 3 Electrical topology and pin description.</i>

Contents

1	Inverter switch	2
2	NTC	4
3	Electrical topology and pin description	5
4	Electrical characteristics (curves)	7
5	Package information	10
	5.1 ACEPACK DMT-32 package information	10
	Revision history	12

IMPORTANT NOTICE – READ CAREFULLY

STMicroelectronics NV and its subsidiaries (“ST”) reserve the right to make changes, corrections, enhancements, modifications, and improvements to ST products and/or to this document at any time without notice. Purchasers should obtain the latest relevant information on ST products before placing orders. ST products are sold pursuant to ST’s terms and conditions of sale in place at the time of order acknowledgment.

Purchasers are solely responsible for the choice, selection, and use of ST products and ST assumes no liability for application assistance or the design of purchasers’ products.

No license, express or implied, to any intellectual property right is granted by ST herein.

Resale of ST products with provisions different from the information set forth herein shall void any warranty granted by ST for such product.

ST and the ST logo are trademarks of ST. For additional information about ST trademarks, refer to www.st.com/trademarks. All other product or service names are the property of their respective owners.

Information in this document supersedes and replaces information previously supplied in any prior versions of this document.

© 2023 STMicroelectronics – All rights reserved