

Very high accuracy (70 μ V), high bandwidth (3 MHz), high temperature (175 $^{\circ}$ C), zero-drift operational amplifiers

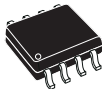

SOT23-5



SO8

Maturity status link

[TSZ181H1, TSZ182H1](#)

Related products

TSZ181H, TSZ182H	For - 40 / 150 $^{\circ}$ C range
TSZ181, TSZ182	For - 40 / 125 $^{\circ}$ C range

Features

- AEC-Q100 qualified 
- Very high accuracy and stability:
 - 70 μ V max. offset voltage at 25 $^{\circ}$ C
 - 100 μ V offset voltage over full temperature range
- Rail-to-rail input and output
- Low supply voltage: 2.2 - 5.5 V
- Low power consumption: 1 mA max. at 5 V
- Gain bandwidth product: 3 MHz
- Automotive qualification
- Extended temperature range: -40 to 175 $^{\circ}$ C
- Micropackage: SOT23-5, SO8
- Benefits:
 - Higher accuracy without calibration
 - Accuracy virtually unaffected by temperature change

Applications

- High accuracy signal conditioning
- Current measurement
- Sensor signal conditioning
- Automotive

Description

The **TSZ181H1** single and **TSZ182H1** dual operational amplifiers feature very low offset voltages with virtually zero drift versus temperature changes. The **TSZ181H1** and **TSZ182H1** offer rail-to-rail input and output, excellent speed/power consumption ratio, and 3 MHz gain bandwidth product, while consuming just 1 mA at 5 V. The device operates over an extended range of -40 to +175 $^{\circ}$ C and features an ultra-low input bias current. These features make the **TSZ181H1** and **TSZ182H1** ideal for high-accuracy high-bandwidth sensor interfaces for automotive environment.

1 Pin connections

Figure 1. Pin connections (top view)

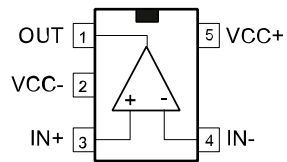

SOT23-5 (TSZ181H1)

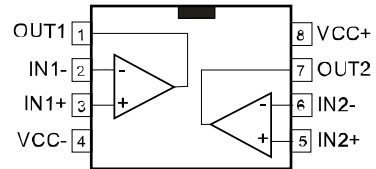

SO8 (TSZ182H1)

2 Absolute maximum ratings and operating conditions

Table 1. Absolute maximum ratings

Symbol	Parameter	Value	Unit
V_{CC}	Supply voltage ⁽¹⁾	6	V
V_{id}	Differential input voltage ⁽²⁾	$\pm V_{CC}$	V
V_{in}	Input voltage ⁽³⁾	$(V_{CC-}) - 0.2$ to $(V_{CC+}) + 0.2$	V
I_{in}	Input current ⁽⁴⁾	10	mA
T_{stg}	Storage temperature	-65 to 150	°C
T_j	Junction temperature	180	°C
R_{th-ja}	Thermal resistance junction to ambient ^{(5) (6)}		°C/W
	SO8	125	
	SOT23-5	250	
ESD	Human Body Model (HBM) ⁽⁷⁾	4	kV
	Charged Device Model (CDM) ⁽⁸⁾	1.5	

1. All voltage values, except differential voltage, are with respect to network ground terminal.
2. The differential voltage is the non-inverting input terminal with respect to the inverting input terminal.
3. $V_{CC} - V_{in}$ must not exceed 6 V, V_{in} must not exceed 6 V.
4. Input current must be limited by a resistor in series with the inputs.
5. R_{th} are typical values.
6. Short-circuits can cause excessive heating and destructive dissipation.
7. Human body model: 100 pF discharged through a 1.5 kΩ resistor between two pins of the device, done for all couples of pin combinations with other pins floating.
8. Charged device model: all pins plus package are charged together to the specified voltage and then discharged directly to ground.

Table 2. Operating conditions

Symbol	Parameter	Value	Unit
V_{CC}	Supply voltage	2.2 to 5.5	V
V_{icm}	Common mode voltage on input pins	$(V_{CC-}) - 0.1$ to $(V_{CC+}) + 0.1$	V
T	Operating free-air temperature range	-40 to 175	°C

3 Electrical characteristics

Table 3. Electrical characteristics at $V_{CC+} = 2.2\text{ V}$, $V_{CC-} = 0\text{ V}$, $V_{icm} = V_{CC}/2$, $T = 25\text{ }^{\circ}\text{C}$, $R_L = 10\text{ k}\Omega$ connected to $V_{CC}/2$ (unless otherwise specified)

Symbol	Parameter	Conditions	Min	Typ	Max	Unit
DC performance						
V_{IO}	Input offset voltage	$T = 25\text{ }^{\circ}\text{C}$		3.5	70	μV
		$T_{min} < T < T_{max}$			100	
$ \Delta V_{IO}/\Delta T $	Input offset voltage drift ⁽¹⁾	$T_{min} < T < T_{max}$			0.26	$\mu\text{V}/^{\circ}\text{C}$
I_{IB}	Input bias current ($V_{OUT} = V_{CC}/2$) ⁽²⁾	$T = 25\text{ }^{\circ}\text{C}$		30	200	pA
		$T_{min} < T < T_{max}$		225		
I_{IO}	Input offset current ($V_{OUT} = V_{CC}/2$) ⁽²⁾	$T = 25\text{ }^{\circ}\text{C}$		60	400	pA
		$T_{min} < T < T_{max}$		150		
CMR1	Common-mode rejection ratio ⁽³⁾ , $V_{ic} = 0\text{ V to } V_{CC}$, $V_{OUT} = V_{CC}/2$, $R_L > 1\text{ M}\Omega$	$T = 25\text{ }^{\circ}\text{C}$	88	115		dB
		$T_{min} < T < T_{max}$	86			
A_{vd}	Large signal voltage gain, $V_{OUT} = 0.5\text{ V to } (V_{CC} - 0.5\text{ V})$	$T = 25\text{ }^{\circ}\text{C}$	102	130		dB
		$T_{min} < T < T_{max}$	92			
V_{OH}	High-level output voltage, $V_{OH} = V_{CC} - V_{OUT}$	$T = 25\text{ }^{\circ}\text{C}$		15	40	mV
		$T_{min} < T < T_{max}$			70	
V_{OL}	Low-level output voltage	$T = 25\text{ }^{\circ}\text{C}$		10	30	mV
		$T_{min} < T < T_{max}$			70	
I_{OUT}	$I_{sink} (V_{OUT} = V_{CC})$	$T = 25\text{ }^{\circ}\text{C}$	4	6		mA
		$T_{min} < T < T_{max}$	1.87			
	$I_{source} (V_{OUT} = 0\text{ V})$	$T = 25\text{ }^{\circ}\text{C}$	3.5	4		
		$T_{min} < T < T_{max}$	1.4			
I_{CC}	Supply current per channel, $V_{OUT} = V_{CC}/2$, $R_L > 1\text{ M}\Omega$	$T = 25\text{ }^{\circ}\text{C}$		0.7	1	
		$T_{min} < T < T_{max}$			1.2	
AC performance						
GBP	Gain bandwidth product, $R_L = 10\text{ k}\Omega$, $C_L = 100\text{ pF}$	$T = 25\text{ }^{\circ}\text{C}$	1.6	2.3		MHz
		$T_{min} < T < T_{max}$	1			
Φ_m	Phase margin	$R_L = 10\text{ k}\Omega$, $C_L = 100\text{ pF}$		59		degrees
G_m	Gain margin			16		dB
SR	Slew rate ⁽⁴⁾	$T = 25\text{ }^{\circ}\text{C}$	3	4.6		V/ μs
		$T_{min} < T < T_{max}$	2.5			
t_s	Settling time	To 0.1%, $V_{in} = 0.8\text{ V}_{pp}$		500		ns
e_n	Equivalent input noise voltage density	$f = 1\text{ kHz}$		50		nV/ $\sqrt{\text{Hz}}$
		$f = 10\text{ kHz}$		50		
e_{n-pp}	Voltage noise	$f = 0.1\text{ to } 10\text{ Hz}$		0.6		μV_{pp}
C_S	Channel separation	$f = 1\text{ kHz}$		120		dB
t_{init}	Initialization time, $G = 100$ ⁽⁵⁾	$T = 25\text{ }^{\circ}\text{C}$		60		μs
		$T_{min} < T < T_{max}$		120		

1. *Input offset measurements are performed on x100 gain configuration. The amplifiers and the gain setting resistors are at the same temperature.*
2. *Guaranteed by design.*
3. *CMR is defined as $20 \times \text{LOG}(\Delta V_{icm} / \Delta V_{io})$.*
4. *Slew rate value is calculated as the average between positive and negative slew rates.*
5. *Initialization time is defined as the delay between the moment when supply voltage exceeds 2.2 V and output voltage stabilization.*

Table 4. Electrical characteristics at $V_{CC+} = 3.3\text{ V}$, $V_{CC-} = 0\text{ V}$, $V_{icm} = V_{CC}/2$, $T = 25\text{ }^{\circ}\text{C}$, $R_L = 10\text{ k}\Omega$ connected to $V_{CC}/2$ (unless otherwise specified)

Symbol	Parameter	Conditions	Min	Typ	Max	Unit
DC performance						
V_{IO}	Input offset voltage	$T = 25\text{ }^{\circ}\text{C}$		2	70	μV
		$T_{min} < T < T_{max}$			100	
$ \Delta V_{IO}/\Delta T $	Input offset voltage drift ⁽¹⁾	$T_{min} < T < T_{max}$			0.26	$\mu\text{V}/^{\circ}\text{C}$
I_{IB}	Input bias current ($V_{OUT} = V_{CC}/2$) ⁽²⁾	$T = 25\text{ }^{\circ}\text{C}$		30	200	pA
		$T_{min} < T < T_{max}$		225		
I_{IO}	Input offset current ($V_{OUT} = V_{CC}/2$) ⁽²⁾	$T = 25\text{ }^{\circ}\text{C}$		60	400	
		$T_{min} < T < T_{max}$		150		
CMR1	Common-mode rejection ratio ⁽³⁾ , $V_{ic} = 0\text{ V to } V_{CC}$, $V_{OUT} = V_{CC}/2$, $R_L > 1\text{ M}\Omega$	$T = 25\text{ }^{\circ}\text{C}$	96	120		
		$T_{min} < T < T_{max}$	94			
CMR2	Common-mode rejection ratio ⁽³⁾ , $V_{OUT} = V_{CC}/2$, $R_L > 1\text{ M}\Omega$	$T = 25\text{ }^{\circ}\text{C}$, $V_{ic} = 0\text{ to } V_{CC} - 1.8\text{ V}$	109	132		dB
		$T_{min} < T < T_{max}$, $V_{ic} = 0\text{ to } V_{CC} - 2\text{ V}$	103			
A_{vd}	Large signal voltage gain, $V_{OUT} = 0.5\text{ V to } (V_{CC} - 0.5\text{ V})$	$T = 25\text{ }^{\circ}\text{C}$	110	138		
		$T_{min} < T < T_{max}$	95			
V_{OH}	High-level output voltage, $V_{OH} = V_{CC} - V_{OUT}$	$T = 25\text{ }^{\circ}\text{C}$		16	40	mV
		$T_{min} < T < T_{max}$			70	
V_{OL}	Low-level output voltage	$T = 25\text{ }^{\circ}\text{C}$		11	30	
		$T_{min} < T < T_{max}$			70	
I_{OUT}	I_{sink} ($V_{OUT} = V_{CC}$)	$T = 25\text{ }^{\circ}\text{C}$	10	15		mA
		$T_{min} < T < T_{max}$	6.1			
	I_{source} ($V_{OUT} = 0\text{ V}$)	$T = 25\text{ }^{\circ}\text{C}$	6	11		
		$T_{min} < T < T_{max}$	2.8			
I_{CC}	Supply current per channel, $V_{OUT} = V_{CC}/2$, $R_L > 1\text{ M}\Omega$	$T = 25\text{ }^{\circ}\text{C}$		0.7	1	
		$T_{min} < T < T_{max}$			1.2	
AC performance						
GBP	Gain bandwidth product, $R_L = 10\text{ k}\Omega$, $C_L = 100\text{ pF}$	$T = 25\text{ }^{\circ}\text{C}$	2	2.8		MHz
		$T_{min} < T < T_{max}$	1.2			
Φ_m	Phase margin	$R_L = 10\text{ k}\Omega$, $C_L = 100\text{ pF}$		56		degrees
G_m	Gain margin			15		dB
SR	Slew rate ⁽⁴⁾	$T = 25\text{ }^{\circ}\text{C}$	2.6	4.5		V/ μs
		$T_{min} < T < T_{max}$	2.1			
t_s	Settling time	To 0.1%, $V_{in} = 1.2\text{ Vpp}$		550		ns
e_n	Equivalent input noise voltage density	$f = 1\text{ kHz}$		40		nV/ $\sqrt{\text{Hz}}$
		$f = 10\text{ kHz}$		40		
e_{n-pp}	Voltage noise	$f = 0.1\text{ to } 10\text{ Hz}$		0.5		μVpp
C_S	Channel separation	$f = 1\text{ kHz}$		120		dB
t_{init}	Initialization time, $G = 100$ ⁽⁵⁾	$T = 25\text{ }^{\circ}\text{C}$		60		μs
		$T_{min} < T < T_{max}$		120		

1. *Input offset measurements are performed on x100 gain configuration. The amplifiers and the gain setting resistors are at the same temperature.*
2. *Guaranteed by design.*
3. *CMR is defined as $20 \times \text{LOG}(\Delta V_{icm} / \Delta V_{io})$*
4. *Slew rate value is calculated as the average between positive and negative slew rates.*
5. *Initialization time is defined as the delay between the moment when supply voltage exceeds 2.2 V and output voltage stabilization.*

Table 5. Electrical characteristics at $V_{CC+} = 5\text{ V}$, $V_{CC-} = 0\text{ V}$, $V_{icm} = V_{CC}/2$, $T = 25\text{ }^{\circ}\text{C}$, $R_L = 10\text{ k}\Omega$ connected to $V_{CC}/2$ (unless otherwise specified)

Symbol	Parameter	Conditions	Min	Typ	Max	Unit
DC performance						
V_{IO}	Input offset voltage	$T = 25\text{ }^{\circ}\text{C}$		1	70	μV
		$T_{min} < T < T_{max}$			100	
$ \Delta V_{IO}/\Delta T $	Input offset voltage drift ⁽⁵⁾	$T_{min} < T < T_{max}$			0.26	$\mu\text{V}/^{\circ}\text{C}$
I_{IB}	Input bias current ($V_{OUT} = V_{CC}/2$) ⁽²⁾	$T = 25\text{ }^{\circ}\text{C}$		30	200	μA
		$T_{min} < T < T_{max}$		225		
I_{IO}	Input offset current ($V_{OUT} = V_{CC}/2$) ⁽²⁾	$T = 25\text{ }^{\circ}\text{C}$		60	400	μA
		$T_{min} < T < T_{max}$		150		
CMR1	Common-mode rejection ratio ⁽³⁾ , $V_{ic} = 0\text{ V to }V_{CC}$, $V_{OUT} = V_{CC}/2$, $R_L > 1\text{ M}\Omega$	$T = 25\text{ }^{\circ}\text{C}$	103	126		dB
		$T_{min} < T < T_{max}$	101			
CMR2	Common-mode rejection ratio ⁽³⁾ , $V_{OUT} = V_{CC}/2$, $R_L > 1\text{ M}\Omega$	$T = 25\text{ }^{\circ}\text{C}$ $V_{ic} = 0\text{ to }V_{CC} - 1.8\text{ V}$	112	136		dB
		$T_{min} < T < T_{max}$, $V_{ic} = 0\text{ to }V_{CC} - 2\text{ V}$	106			
SVR1	Supply voltage rejection ratio ⁽⁴⁾ , $V_{CC} = 2.2\text{ to }5.5\text{ V}$, $V_{ic} = 0\text{ V}$, $R_L > 1\text{ M}\Omega$	$T = 25\text{ }^{\circ}\text{C}$	101	123		dB
		$T_{min} < T < T_{max}$	99			
A_{vd}	Large signal voltage gain, $V_{OUT} = 0.5\text{ V to } (V_{CC} - 0.5\text{ V})$	$T = 25\text{ }^{\circ}\text{C}$	110	144		dB
		$T_{min} < T < T_{max}$	104			
EMIRR	EMI rejection ratio ⁽⁵⁾	$V_{RF} = 100\text{ mVp}$, $f = 400\text{ MHz}$		52		dB
		$V_{RF} = 100\text{ mVp}$, $f = 900\text{ MHz}$		52		
		$V_{RF} = 100\text{ mVp}$, $f = 1800\text{ MHz}$		72		
		$V_{RF} = 100\text{ mVp}$, $f = 2400\text{ MHz}$		85		
V_{OH}	High-level output voltage, $V_{OH} = V_{CC} - V_{OUT}$	$T = 25\text{ }^{\circ}\text{C}$		18	40	mV
		$T_{min} < T < T_{max}$			70	
V_{OL}	Low-level output voltage	$T = 25\text{ }^{\circ}\text{C}$		13	30	mV
		$T_{min} < T < T_{max}$			70	
I_{OUT}	$I_{sink} (V_{OUT} = V_{CC})$	$T = 25\text{ }^{\circ}\text{C}$	20	29		mA
		$T_{min} < T < T_{max}$	12			
	$I_{source} (V_{OUT} = 0\text{ V})$	$T = 25\text{ }^{\circ}\text{C}$	15	25		
		$T_{min} < T < T_{max}$	7			
I_{CC}	Supply current per channel, $V_{OUT} = V_{CC}/2$, $R_L > 1\text{ M}\Omega$	$T = 25\text{ }^{\circ}\text{C}$		0.8	1	mA
		$T_{min} < T < T_{max}$			1.2	
AC performance						
GBP	Gain bandwidth product, $R_L = 10\text{ k}\Omega$, $C_L = 100\text{ pF}$	$T = 25\text{ }^{\circ}\text{C}$	2	3		MHz
		$T_{min} < T < T_{max}$	1.2			

Symbol	Parameter	Conditions	Min	Typ	Max	Unit
Φ_m	Phase margin	$R_L = 10\text{ k}\Omega, C_L = 100\text{ pF}$		56		degrees
G_m	Gain margin			15		dB
SR	Slew rate ⁽⁶⁾	$T = 25\text{ }^\circ\text{C}$	2.9	4.7		V/ μs
		$T_{\text{min}} < T < T_{\text{max}}$	2.4			
t_s	Settling time	To 0.1%, $V_{\text{in}} = 1.5\text{ Vpp}$		600		ns
		To 0.01%, $V_{\text{in}} = 1\text{ Vpp}$		4		μs
e_n	Equivalent input noise voltage density	$f = 1\text{ kHz}$		37		nV/ $\sqrt{\text{Hz}}$
		$f = 10\text{ kHz}$		37		
$e_{n\text{-pp}}$	Voltage noise	$f = 0.1\text{ to }10\text{ Hz}$		0.4		μVpp
C_S	Channel separation	$f = 100\text{ Hz}$		135		dB
t_{init}	Initialization time, $G = 100$ ⁽⁷⁾	$T = 25\text{ }^\circ\text{C}$		60		μs
		$T_{\text{min}} < T < T_{\text{max}}$		100		

1. Input offset measurements are performed on x100 gain configuration. The amplifiers and the gain setting resistors are at the same temperature.
2. Guaranteed by design.
3. CMR is defined as $20 \times \text{LOG}(\Delta V_{\text{icm}} / \Delta V_{\text{io}})$.
4. SVR is defined as $20 \times \text{LOG}(\Delta V_{\text{cc}} / \Delta V_{\text{io}})$.
5. EMIRR is defined as $-20 \text{Log}(V_{\text{RF_Peak}} / \Delta V_{\text{io}})$. Tested on the MiniSO8 package, RF injection on the IN- pin.
6. Slew rate value is calculated as the average between positive and negative slew rates.
7. Initialization time is defined as the delay between the moment when supply voltage exceeds 2.2 V and output voltage stabilization.

4 Typical performance characteristics

Figure 2. Supply current vs. supply voltage

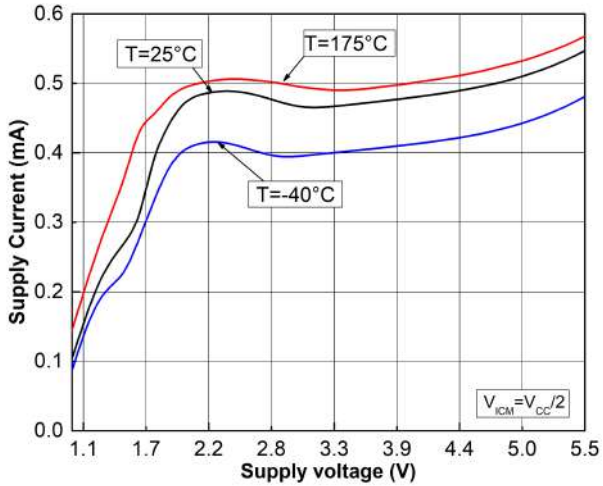

Figure 3. Input offset voltage distribution at $V_{CC} = 5\text{ V}$

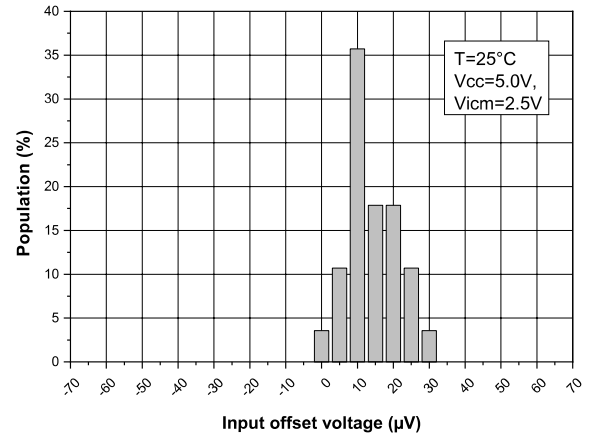

Figure 4. Input offset voltage distribution at $V_{CC} = 3.3\text{ V}$

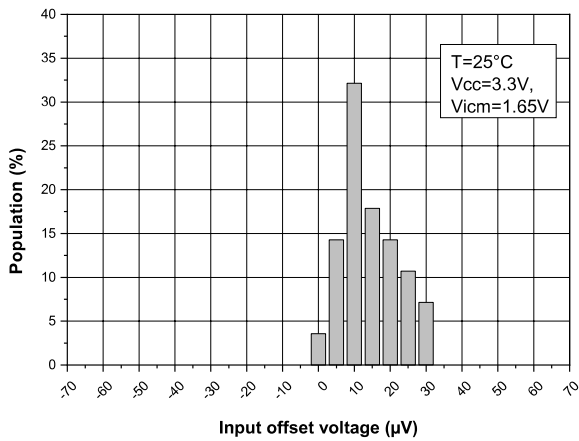

Figure 5. Input offset voltage distribution at $V_{CC} = 2.2\text{ V}$

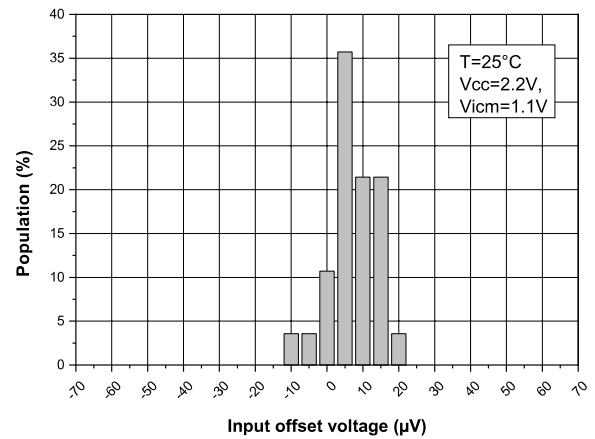

Figure 6. Input offset voltage distribution at $V_{CC} = 5\text{ V}$,
 $T = 175\text{ }^{\circ}\text{C}$

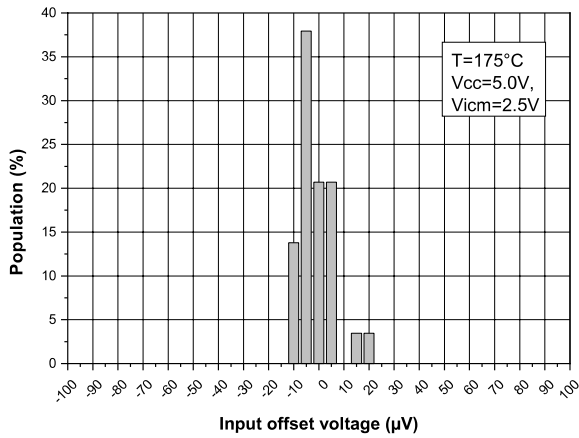

Figure 7. Input offset voltage distribution at $V_{CC} = 5\text{ V}$,
 $T = -40\text{ }^{\circ}\text{C}$

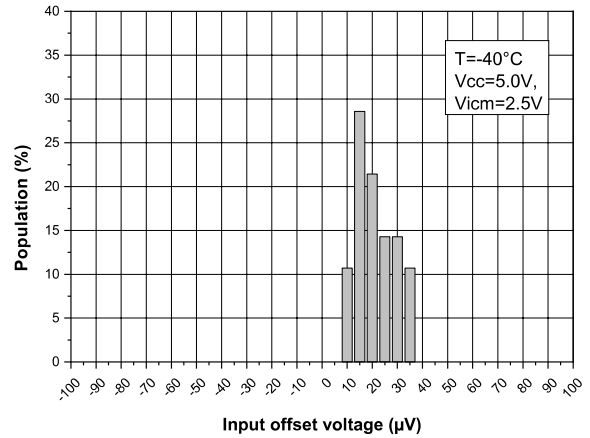

Figure 8. Input offset voltage distribution at $V_{CC} = 2.2\text{ V}$,
 $T = 175\text{ }^{\circ}\text{C}$

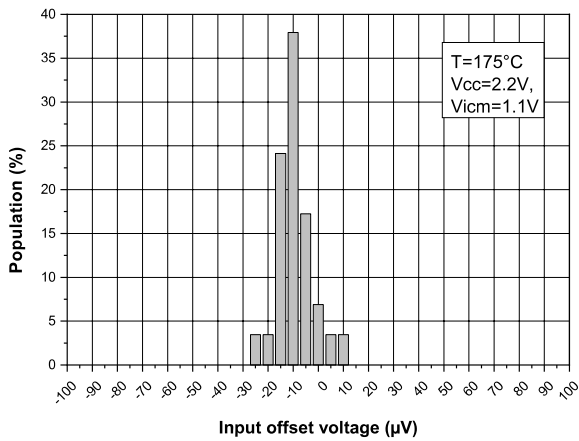

Figure 9. Input offset voltage distribution at $V_{CC} = 2.2\text{ V}$,
 $T = -40\text{ }^{\circ}\text{C}$

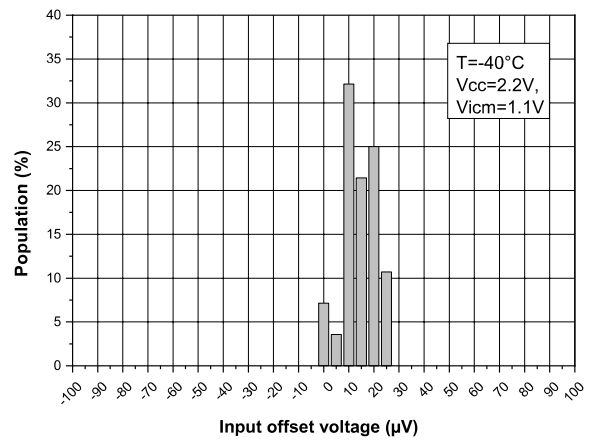

Figure 10. Input offset voltage vs. supply voltage

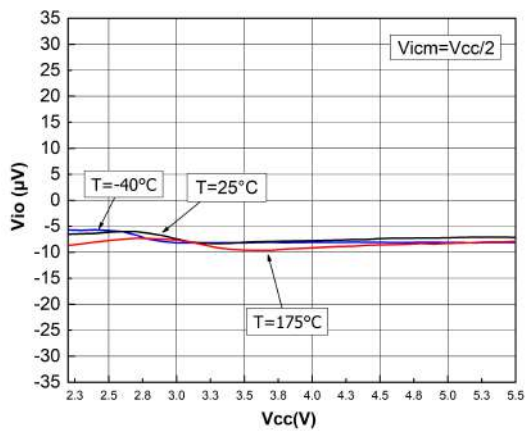

Figure 11. Input offset voltage vs. input common mode at
 $V_{CC} = 5.5\text{ V}$

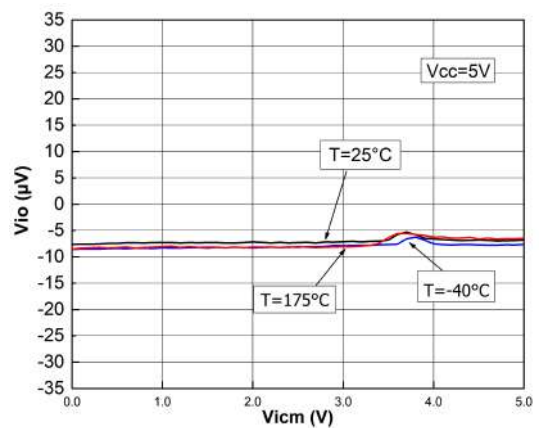

Figure 12. Input offset voltage vs. input common mode at $V_{CC} = 3.3\text{ V}$

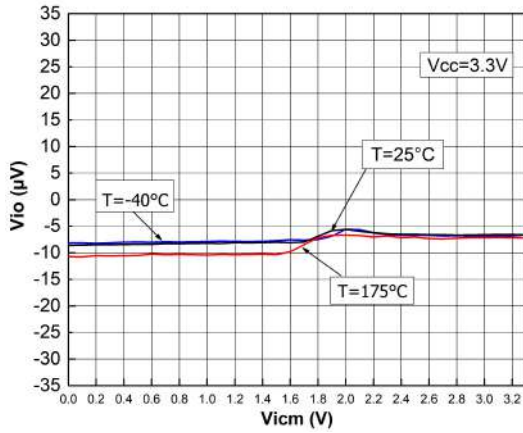

Figure 13. Input offset voltage vs. input common mode at $V_{CC} = 2.2\text{ V}$

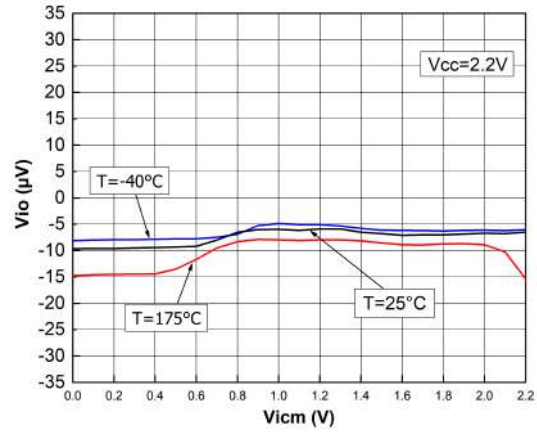

Figure 14. Input offset voltage vs. temperature

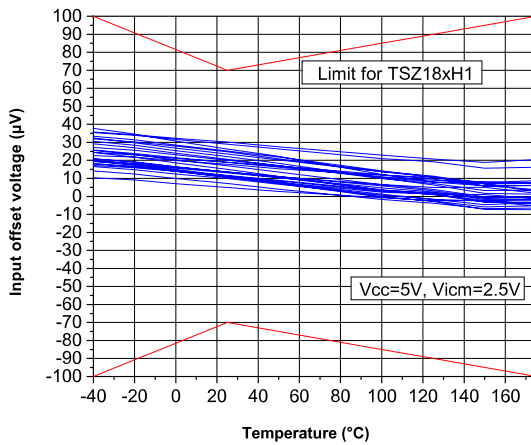

Figure 15. V_{OH} vs. supply voltage

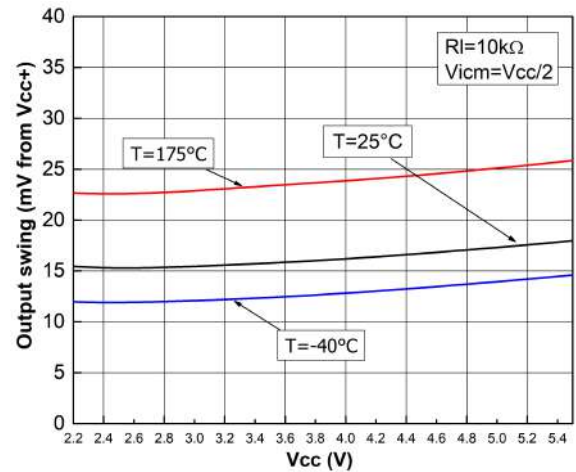

Figure 16. V_{OL} vs. supply voltage

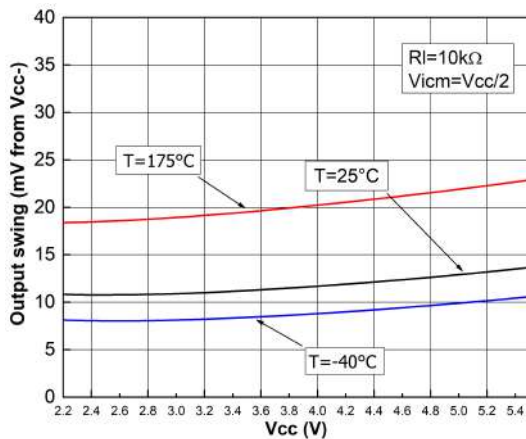

Figure 17. Output current vs. output voltage at $V_{CC} = 5\text{ V}$

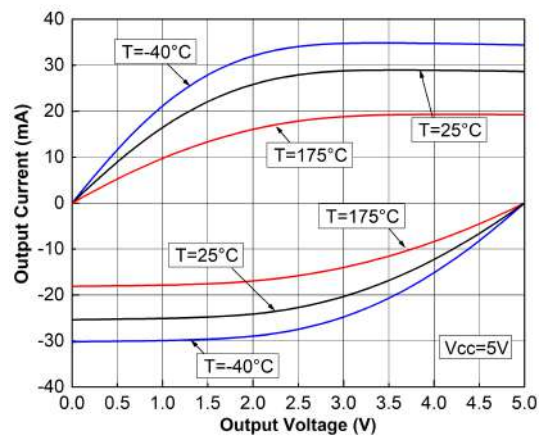

Figure 18. Output current vs. output voltage at $V_{CC} = 2.2\text{ V}$

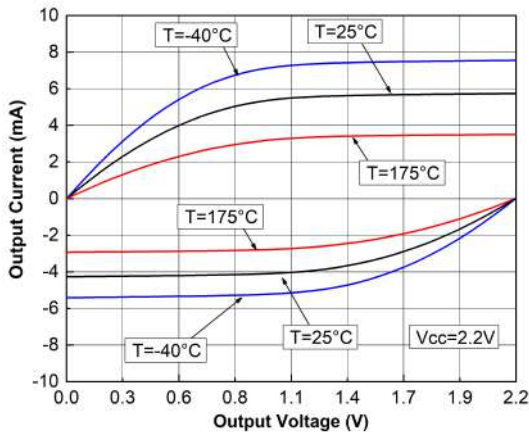

Figure 19. Input bias current vs. common-mode at $V_{CC} = 5\text{ V}$

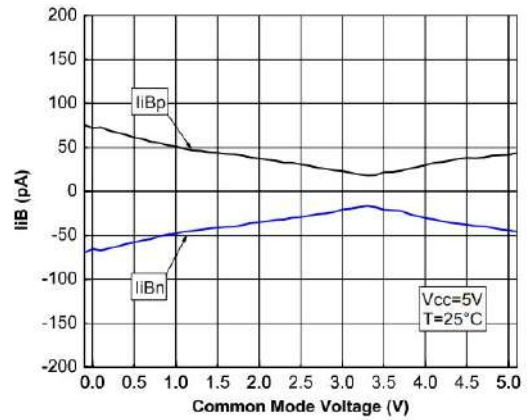

Figure 20. Input bias current vs. temp. at $V_{CC} = 5\text{ V}$

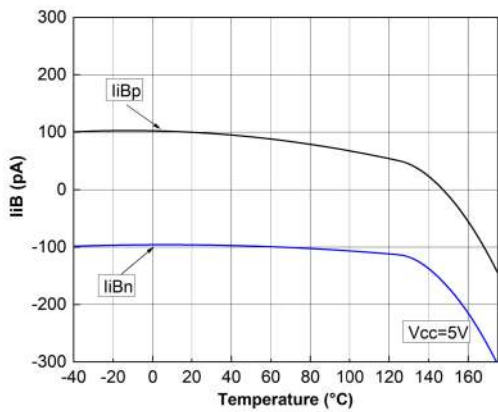

Figure 21. Output rail linearity

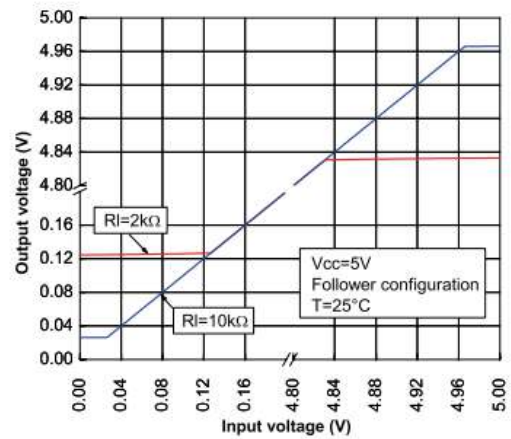

Figure 22. Bode diagram at $V_{CC} = 5\text{ V}$

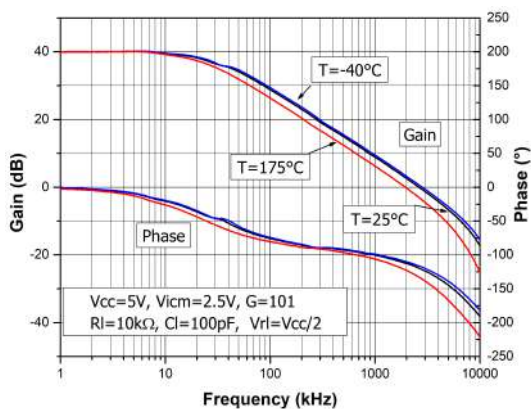

Figure 23. Bode diagram at $V_{CC} = 2.2\text{ V}$

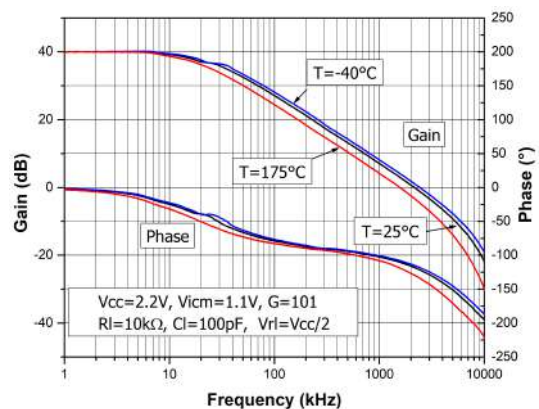

Figure 24. Bode diagram at $V_{CC} = 3.3\text{ V}$

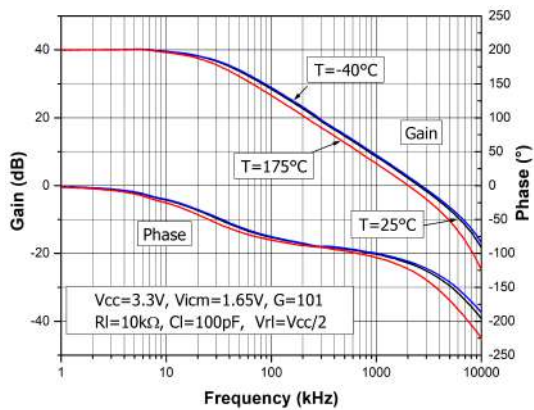

Figure 25. Open loop gain vs. frequency

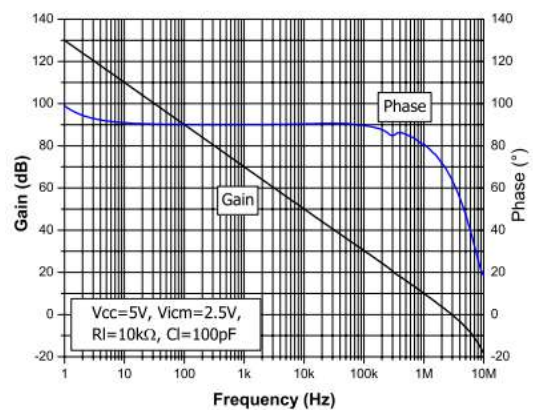

Figure 26. Positive slew rate vs. supply voltage

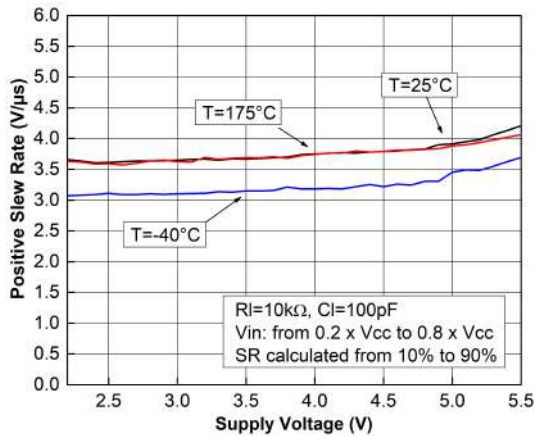

Figure 27. Negative slew rate vs. supply voltage

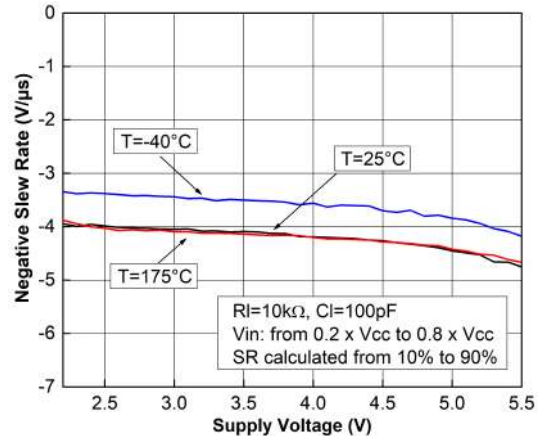

Figure 28. Noise 0.1 – 10 Hz vs. time

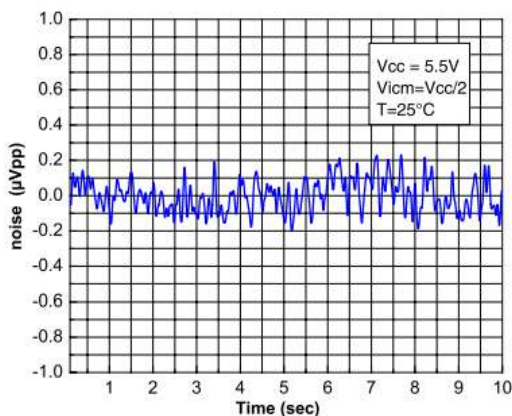

Figure 29. Noise vs. frequency

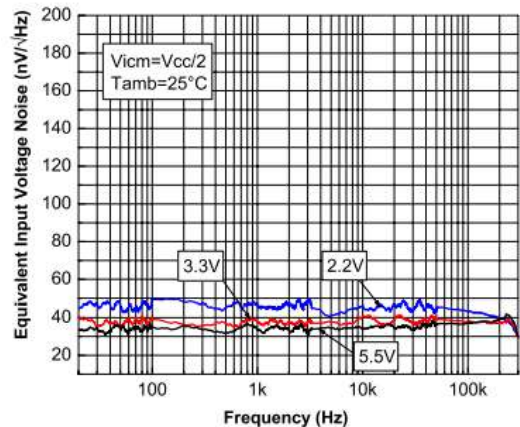

Figure 30. Output overshoot vs. load capacitance

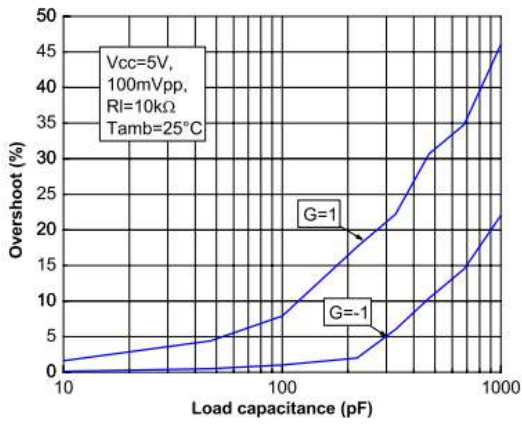

Figure 31. Small signal $V_{CC} = 5 V$

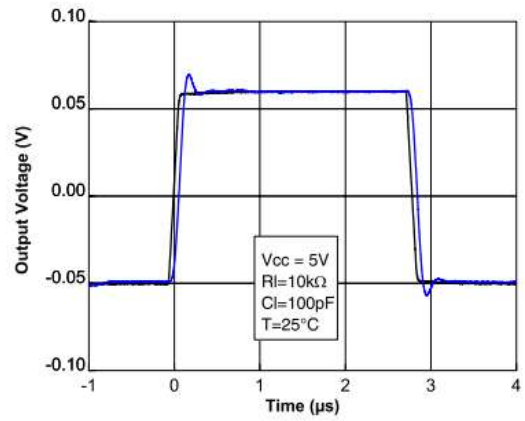

Figure 32. Small signal $V_{CC} = 2.2 V$

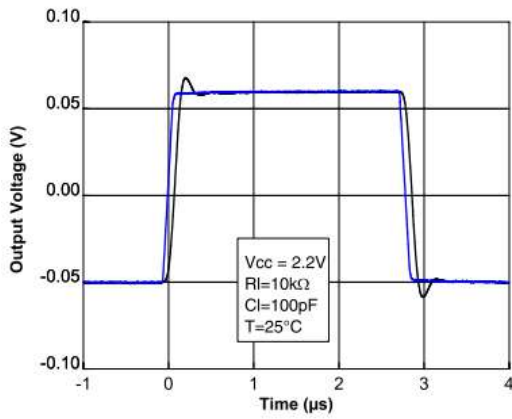

Figure 33. Large signal $V_{CC} = 5 V$

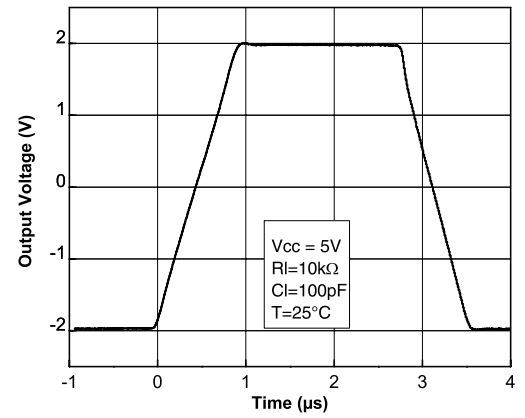

Figure 34. Large signal $V_{CC} = 2.2 V$

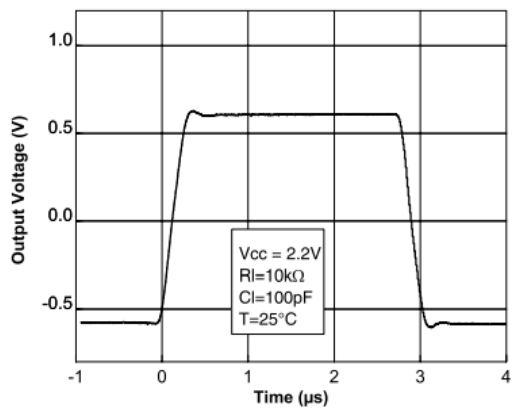

Figure 35. Negative overv. recovery $V_{CC} = 2.2 V$

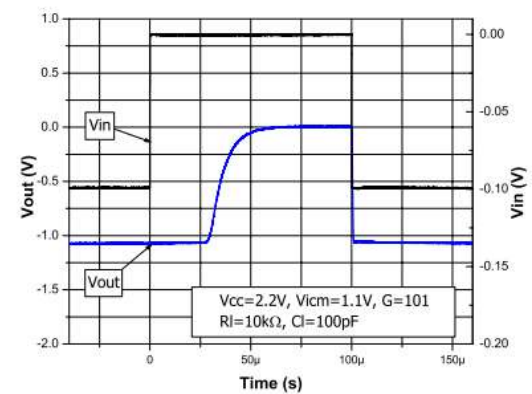

Figure 36. Positive overvoltage recovery $V_{CC} = 5\text{ V}$

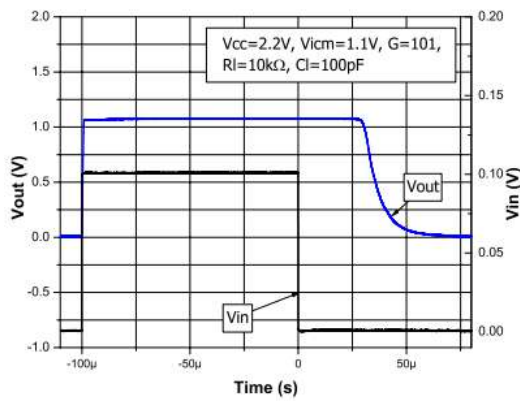

Figure 37. Output impedance vs. frequency

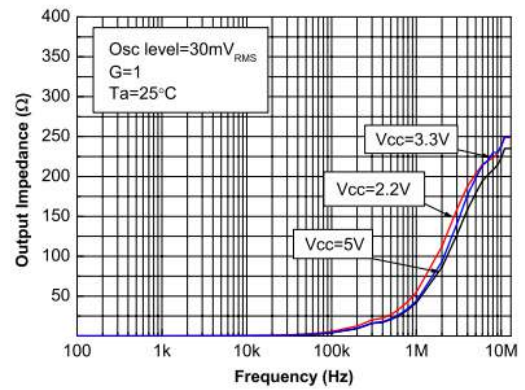

Figure 38. Settling time positive step (-2 V to 0 V)

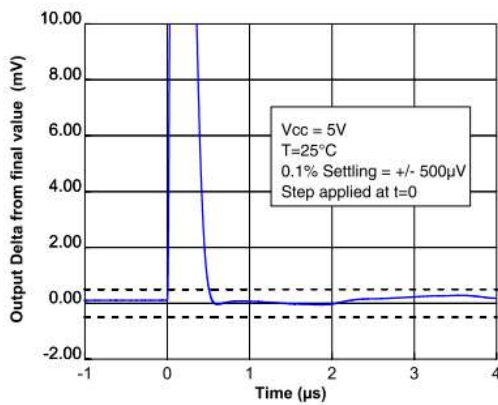

Figure 39. Settling time negative step (2 V to 0 V)

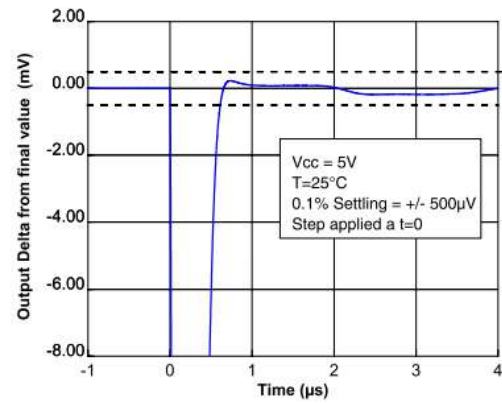

Figure 40. Settling time positive step (-0.8 V to 0 V)

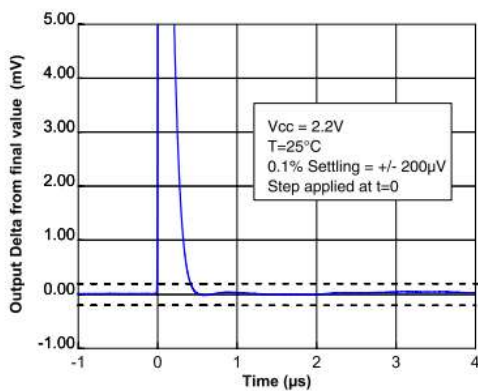

Figure 41. Settling time negative step (0.8 V to 0 V)

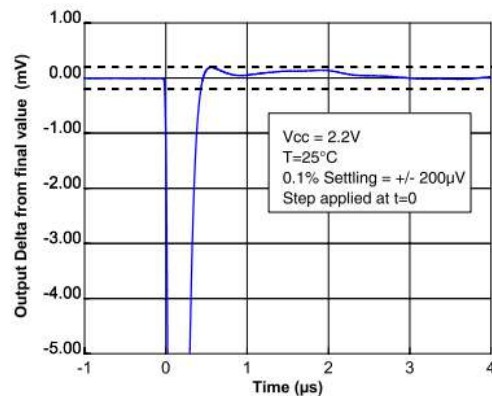

Figure 42. Maximum output voltage vs. frequency

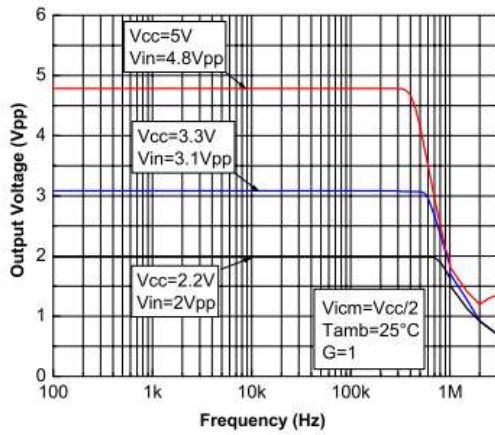

Figure 43. Crosstalk vs. frequency

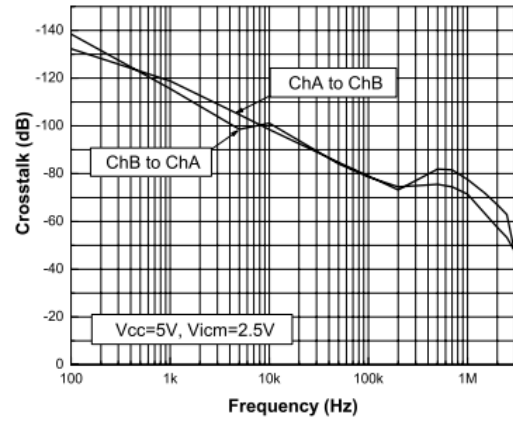
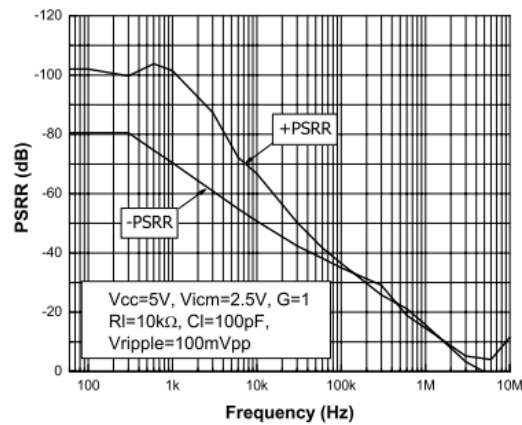

Figure 44. PSSR vs. frequency



5 Package information

In order to meet environmental requirements, ST offers these devices in different grades of **ECOPACK** packages, depending on their level of environmental compliance. ECOPACK specifications, grade definitions and product status are available at: www.st.com. ECOPACK is an ST trademark.

5.1 SO8 package information

Figure 45. SO8 package outline

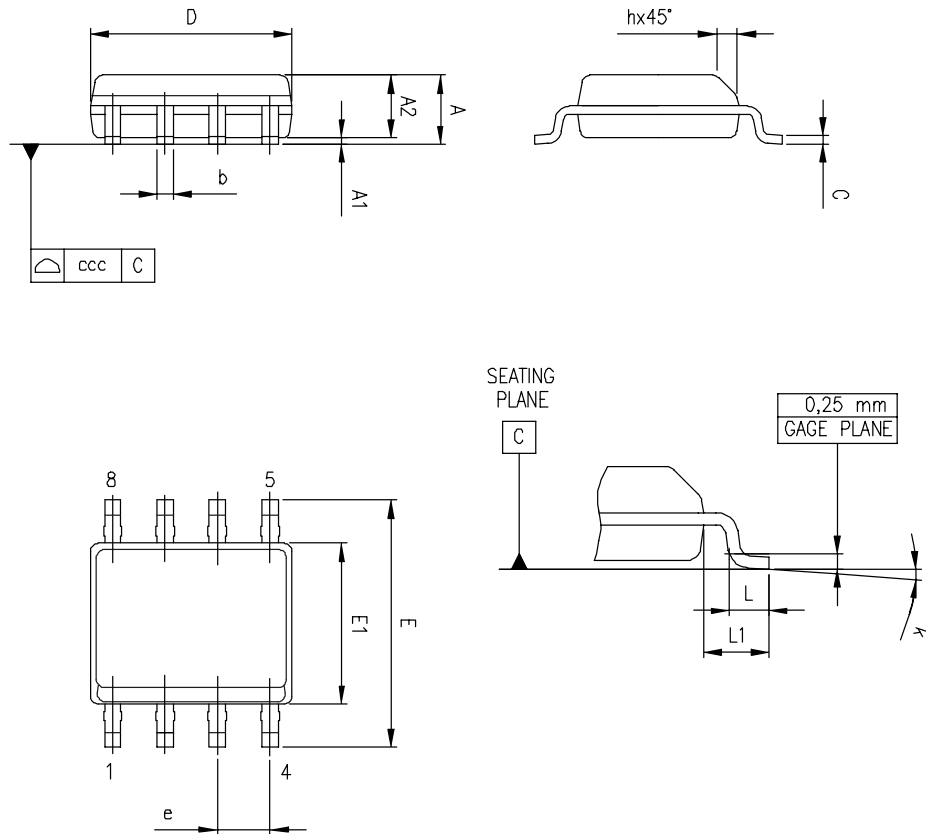

Table 6. SO8 mechanical data

Dim.	mm			Inches		
	Min.	Typ.	Max.	Min.	Typ.	Max.
A			1.75			0.069
A1	0.1		0.25	0.004		0.01
A2	1.25			0.049		
b	0.28		0.48	0.011		0.019
c	0.17		0.23	0.007		0.01
D	4.8	4.9	5	0.189	0.193	0.197
E	5.8	6	6.2	0.228	0.236	0.244
E1	3.8	3.9	4	0.15	0.154	0.157
e		1.27			0.05	
h	0.25		0.5	0.01		0.02
L	0.4		1.27	0.016		0.05
L1		1.04			0.04	
k	0		8 °	1 °		8 °
ccc			0.1			0.004

5.2 SOT23-5 package information

Figure 46. SOT23-5 package outline

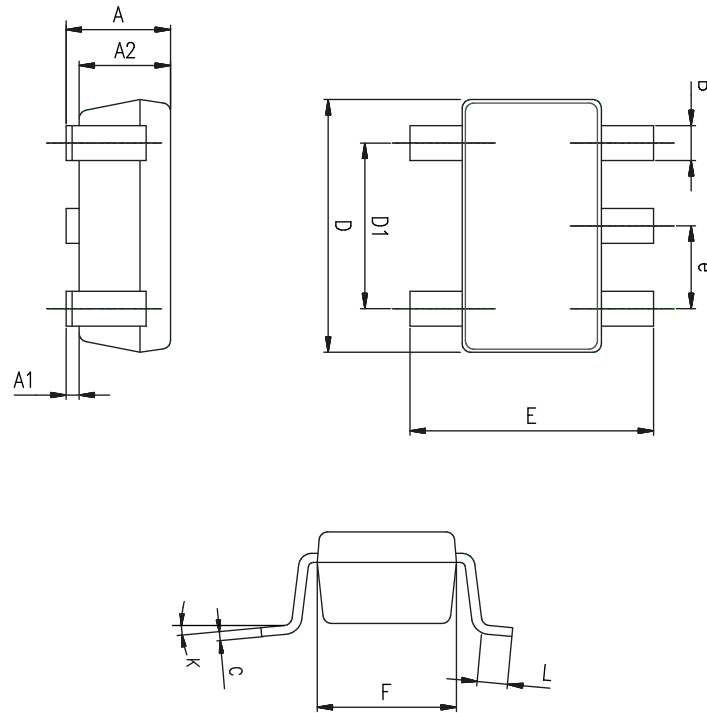

Table 7. SOT23-5 mechanical data

Ref.	Dimensions					
	Millimeters			Inches		
	Min.	Typ.	Max.	Min.	Typ.	Max.
A	0.90	1.20	1.45	0.035	0.047	0.057
A1			0.15			0.006
A2	0.90	1.05	1.30	0.035	0.041	0.051
B	0.35	0.40	0.50	0.014	0.016	0.020
C	0.09	0.15	0.20	0.004	0.006	0.008
D	2.80	2.90	3.00	0.110	0.114	0.118
D1		1.90			0.075	
e		0.95			0.037	
E	2.60	2.80	3.00	0.102	0.110	0.118
F	1.50	1.60	1.75	0.059	0.063	0.069
L	0.10	0.35	0.60	0.004	0.014	0.024
K	0 degrees		10 degrees	0 degrees		10 degrees

6 Ordering information

Table 8. Order code

Order code	Package	Packaging	Marking
TSZ181H1YLT ⁽¹⁾	SOT23-5	Tape & Reel	K230
TSZ182H1YDT ⁽¹⁾	SO8	Tape & Reel	Z182H1Y

1. Qualified and characterized according to AEC Q100 and Q003 or equivalent, advanced screening according to AEC Q001 & Q002 or equivalent.

Revision history

Table 9. Document revision history

Date	Revision	Changes
01-Mar-2021	1	Initial release.
17-Jan-2023	2	Added new TSZ181H1YLT part number in Table 8 . Order code and new SOT23-5 package information. Updated title, figure, features and description on the cover page. Updated Figure 1 , Figure 3 , Figure 4 , Figure 5 , Figure 6 , Figure 7 , Figure 8 , Figure 9 and Figure 14 .

Contents

1	Pin connections	2
2	Absolute maximum ratings and operating conditions	3
3	Electrical characteristics	4
4	Typical performance characteristics	10
5	Package information	18
5.1	SO8 package information	19
5.2	SOT23-5 package information	20
6	Ordering information	21
	Revision history	22

List of tables

Table 1.	Absolute maximum ratings	3
Table 2.	Operating conditions	3
Table 3.	Electrical characteristics at $V_{cc+} = 2.2\text{ V}$, $V_{cc-} = 0\text{ V}$, $V_{icm} = V_{cc}/2$, $T = 25\text{ }^{\circ}\text{C}$, $R_L = 10\text{ k}\Omega$ connected to $V_{cc}/2$ (unless otherwise specified)	4
Table 4.	Electrical characteristics at $V_{cc+} = 3.3\text{ V}$, $V_{cc-} = 0\text{ V}$, $V_{icm} = V_{cc}/2$, $T = 25\text{ }^{\circ}\text{C}$, $R_L = 10\text{ k}\Omega$ connected to $V_{cc}/2$ (unless otherwise specified)	6
Table 5.	Electrical characteristics at $V_{cc+} = 5\text{ V}$, $V_{cc-} = 0\text{ V}$, $V_{icm} = V_{cc}/2$, $T = 25\text{ }^{\circ}\text{C}$, $R_L = 10\text{ k}\Omega$ connected to $V_{cc}/2$ (unless otherwise specified)	8
Table 6.	SO8 mechanical data	19
Table 7.	SOT23-5 mechanical data	20
Table 8.	Order code	21
Table 9.	Document revision history	22

List of figures

Figure 1.	Pin connections (top view)	2
Figure 2.	Supply current vs. supply voltage	10
Figure 3.	Input offset voltage distribution at $V_{CC} = 5\text{ V}$	10
Figure 4.	Input offset voltage distribution at $V_{CC} = 3.3\text{ V}$	10
Figure 5.	Input offset voltage distribution at $V_{CC} = 2.2\text{ V}$	10
Figure 6.	Input offset voltage distribution at $V_{CC} = 5\text{ V}$, $T = 175\text{ }^{\circ}\text{C}$	11
Figure 7.	Input offset voltage distribution at $V_{CC} = 5\text{ V}$, $T = -40\text{ }^{\circ}\text{C}$	11
Figure 8.	Input offset voltage distribution at $V_{CC} = 2.2\text{ V}$, $T = 175\text{ }^{\circ}\text{C}$	11
Figure 9.	Input offset voltage distribution at $V_{CC} = 2.2\text{ V}$, $T = -40\text{ }^{\circ}\text{C}$	11
Figure 10.	Input offset voltage vs. supply voltage	11
Figure 11.	Input offset voltage vs. input common mode at $V_{CC} = 5.5\text{ V}$	11
Figure 12.	Input offset voltage vs. input common mode at $V_{CC} = 3.3\text{ V}$	12
Figure 13.	Input offset voltage vs. input common mode at $V_{CC} = 2.2\text{ V}$	12
Figure 14.	Input offset voltage vs. temperature.	12
Figure 15.	V_{OH} vs. supply voltage	12
Figure 16.	V_{OL} vs. supply voltage.	12
Figure 17.	Output current vs. output voltage at $V_{CC} = 5\text{ V}$	12
Figure 18.	Output current vs. output voltage at $V_{CC} = 2.2\text{ V}$	13
Figure 19.	Input bias current vs. common-mode at $V_{CC} = 5\text{ V}$	13
Figure 20.	Input bias current vs. temp. at $V_{CC} = 5\text{ V}$	13
Figure 21.	Output rail linearity	13
Figure 22.	Bode diagram at $V_{CC} = 5\text{ V}$	13
Figure 23.	Bode diagram at $V_{CC} = 2.2\text{ V}$	13
Figure 24.	Bode diagram at $V_{CC} = 3.3\text{ V}$	14
Figure 25.	Open loop gain vs. frequency	14
Figure 26.	Positive slew rate vs. supply voltage	14
Figure 27.	Negative slew rate vs. supply voltage	14
Figure 28.	Noise 0.1 – 10 Hz vs. time	14
Figure 29.	Noise vs. frequency.	14
Figure 30.	Output overshoot vs. load capacitance	15
Figure 31.	Small signal $V_{CC} = 5\text{ V}$	15
Figure 32.	Small signal $V_{CC} = 2.2\text{ V}$	15
Figure 33.	Large signal $V_{CC} = 5\text{ V}$	15
Figure 34.	Large signal $V_{CC} = 2.2\text{ V}$	15
Figure 35.	Negative overv. recovery $V_{CC} = 2.2\text{ V}$	15
Figure 36.	Positive overvoltage recovery $V_{CC} = 5\text{ V}$	16
Figure 37.	Output impedance vs. frequency.	16
Figure 38.	Settling time positive step (-2 V to 0 V).	16
Figure 39.	Settling time negative step (2 V to 0 V)	16
Figure 40.	Settling time positive step (-0.8 V to 0 V)	16
Figure 41.	Settling time negative step (0.8 V to 0 V)	16
Figure 42.	Maximum output voltage vs. frequency	17
Figure 43.	Crosstalk vs. frequency	17
Figure 44.	PSSR vs. frequency	17
Figure 45.	SO8 package outline	19
Figure 46.	SOT23-5 package outline	20

IMPORTANT NOTICE – READ CAREFULLY

STMicroelectronics NV and its subsidiaries (“ST”) reserve the right to make changes, corrections, enhancements, modifications, and improvements to ST products and/or to this document at any time without notice. Purchasers should obtain the latest relevant information on ST products before placing orders. ST products are sold pursuant to ST’s terms and conditions of sale in place at the time of order acknowledgment.

Purchasers are solely responsible for the choice, selection, and use of ST products and ST assumes no liability for application assistance or the design of purchasers’ products.

No license, express or implied, to any intellectual property right is granted by ST herein.

Resale of ST products with provisions different from the information set forth herein shall void any warranty granted by ST for such product.

ST and the ST logo are trademarks of ST. For additional information about ST trademarks, refer to www.st.com/trademarks. All other product or service names are the property of their respective owners.

Information in this document supersedes and replaces information previously supplied in any prior versions of this document.

© 2023 STMicroelectronics – All rights reserved