

4.5 V to 20 V Input, 25 A microBRICK® DC/DC Regulator Module With PMBus Interface

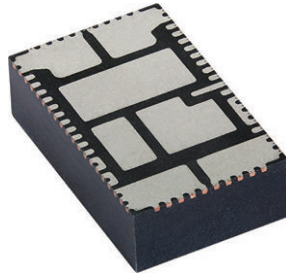

Top view



Bottom view

LINKS TO ADDITIONAL RESOURCES



DESCRIPTION

The SiC951 is a PMBus 1.3 compliant non-isolated DC/DC buck regulator module with integrated MOSFETs and inductor in a 10.6 mm x 6.5 mm x 3 mm thermally efficient package. It is capable of supplying 25 A continuously with 30 A peak. Its output voltage is digitally adjustable from 0.3 V to 5.5 V from a 4.5 V to 20 V input with switching frequencies up to 1.5 MHz. The SiC951 can accommodate a variety of applications, including computing, consumer electronics, telecom, and industrial.

SiC951 architecture delivers ultrafast transient response with minimum output capacitance and tight regulation over a broad load range. The device has integrated internal compensation and is stable with any type of output capacitor. The device incorporates a power saving scheme that significantly increases light load efficiency.

The SiC951 allows power block configuration programs to be stored in non volatile memory (NVM). Operation parameters such as V_{OUT} , I_{OUT} , over temperature etc. can all be locally stored and used to determine fault behavior. Operation is firmware based and is field upgradable.

The SiC951 is available in lead (Pb)-free power enhanced MLP59-A6C package.

A full featured GUI and interface board is available to program and facilitate development of SiC951 based systems.

FEATURES

- Versatile
 - Single supply operation from 4.5 V to 20 V input voltage
 - Output current: 25 A continuous with 30 A peak
 - Adjustable output voltage from 0.3 V to 5.5 V
 - Built in 5 V regulator for internal circuits and driver supply
 - 1 % output voltage accuracy over temperature
- Highly efficient
 - Close to 97 % peak efficiency
- Highly configurable
 - PMBus 1.3 compliant with 1 MHz bus speed
 - Internal NVM
 - V_{OUT} adjustability and reading resolution of 2 mV
 - Supports over 50 PMBus commands
 - Ability to support sequential, tracking and simultaneous operation
 - Supports in phase or 180° out of phase synchronization
 - Output voltage source and sink capability
- Robust and reliable
 - V_{IN} , V_{OUT} and temperature reporting over PMBus
 - Over current protection in pulse-by-pulse mode
 - Output over voltage protection
 - Output under voltage protection
 - Over temperature protection with hysteresis
 - Dedicated enable pin for easy power sequencing
 - Power good open drain output
 - Remote sense amplifier with true differential voltage sensing
 - Ultrafast transient response
 - Optional power saving mode

APPLICATIONS

- Servers
- Networking, telecom, storage applications
- Ultrabook, notebook, desktop
- Distributed point of load power architectures
- Storage applications
- DDR memory

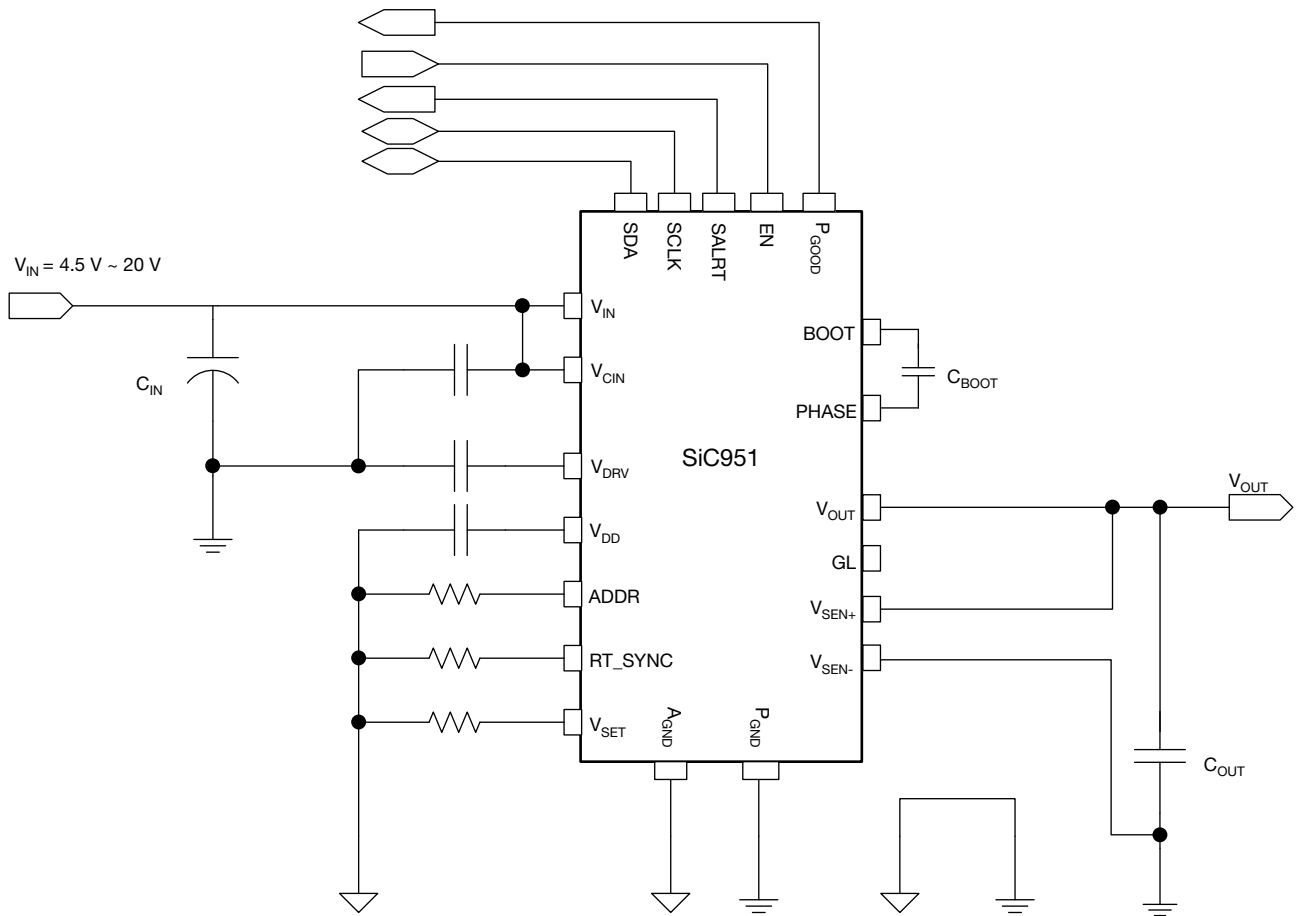
TYPICAL APPLICATION CIRCUIT

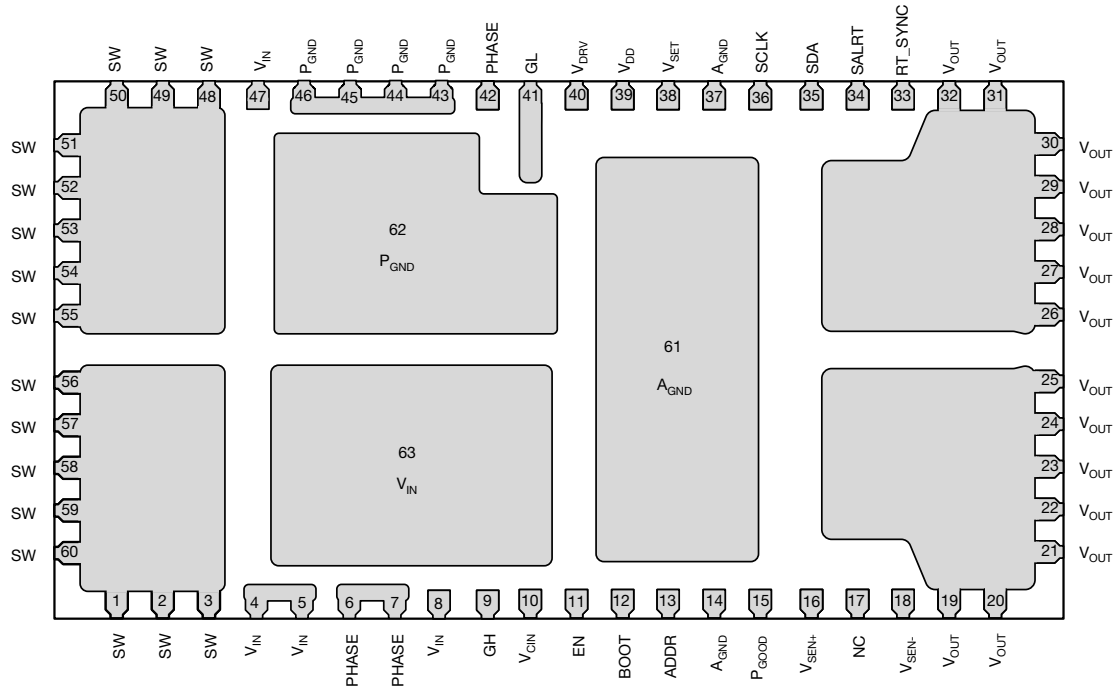
Fig. 1 - Typical Application Circuit

PIN CONFIGURATION

Fig. 2 - Pin Configuration - Transparent View

PIN DESCRIPTION		
PIN NUMBER	SYMBOL	DESCRIPTION
1 to 3, 48 to 60	SW	Switch node
4, 5, 8, 47, 63	V _{IN}	Input voltage for power stage
6, 7, 42	PHASE	Phase node, return of high side gate driver
9	GH	High side gate signal for test purpose
10	V _{CIN}	Input to the internal 5 V LDO. Connect this pin to V _{IN} on PCB
11	EN	Enable pin. Active high
12	BOOT	Bootstrap voltage for high side gate driver
13	ADDR	PMBus address configuration pin
14, 37, 61	A _{GND}	Analog ground
15	P _{GOOD}	Power good pin with open drain connection
16	V _{SEN+}	Positive input for output remote sense
17	NC	Leave this pin not connected
18	V _{SEN-}	Negative input for output remote sense
19 to 32	V _{OUT}	Output voltage terminals
33	RT_SYNC	Clock synchronization pin. Frequency can be set by connecting a resistor to A _{GND} . Pending on master / slave configuration, a clock can be send / receive via the pin
34	SALRT	PMBus alert. Connect to external host interface if desired
35	SDA	PMBus data. Connect to external host interface
36	SCLK	PMBus clock. Connect to external host interface
38	V _{SET}	Output voltage set point by connecting a resistor from V _{SET} to A _{GND}
39	V _{DD}	Internal 5 V circuits supply voltage. V _{DD} is a LDO output, connect a 1 μF decoupling capacitor to A _{GND}
40	V _{DRV}	Supply voltage for internal gate drive. V _{DRV} is a LDO output. Connect a 4.7 μF decoupling capacitor to P _{GND}
41	GL	Low side MOSFET gate monitor
43 to 46, 62	P _{GND}	Power ground. Common return for internal MOSFETs

ORDERING INFORMATION							
PART NUMBER	PART MARKING	V _{DD} , V _{DRV}	LIGHT LOAD MODE	OPERATING JUNCTION TEMPERATURE	PACKAGE	PACKAGING	MINIMUM ORDER QUANTITY
SiC951ED-T1-GE3	SiC951	Internal	Power save mode	-40 °C to +125 °C	MLP60-A6	Tape and reel	1050
SiC951ED-Y1-GE3	SiC951	Internal	Power save mode	-40 °C to +125 °C	MLP60-A6	Tray	210
SiC951EVB-A	Reference board						
SiC951EVB-KIT-A	Reference board kit with dongle and cable						

PART MARKING INFORMATION

	●	= pin 1 indicator
	P/N	= part number code
		= Siliconix logo
		= ESD symbol
	F	= assembly factory code
	Y	= year code
WW	= week code	
LL	= lot code	

ABSOLUTE MAXIMUM RATINGS (T _A = 25 °C, unless otherwise noted)			
ELECTRICAL PARAMETER	CONDITIONS	LIMITS	UNIT
PV _{IN} , V _{IN}	Reference to P _{GND}	-0.3 to +28	V
SW / PH	Reference to P _{GND}	-0.3 to +28	
SW / PH (AC)	Reference to P _{GND} (100 ns)	-8 to +33	
BOOT		-0.3 to V _{PH} + P _{VCC}	
BOOT to SW		-0.3 to +6	
Drive supply voltage (P _{VCC})		-0.3 to +6	
Bias supply voltage (V _{DD})		-0.3 to +6	
A _{GND} to P _{GND}		-0.3 to +0.3	
All other pins	Reference to A _{GND}	-0.3 to V _{DD} + 0.3	
Temperature			
Junction temperature		-40 to +150	°C
Storage temperature		-65 to +150	
Power Dissipation			
Junction-to-ambient thermal impedance (R _{thJA})		10	°C/W
Thermal resistance from junction to case (R _{thJ-C})		2.5	
Thermal resistance from junction to PCB (R _{thJ-PCB})		5	
ESD Protection			
Electrostatic discharge protection	HBM	2	kV
	CDM	750	V

Stresses beyond those listed under "Absolute Maximum Ratings" may cause permanent damage to the device. These are stress ratings only, and functional operation of the device at these or any other conditions beyond those indicated in the operational sections of the specifications is not implied. Exposure to absolute maximum rating / conditions for extended periods may affect device reliability.



RECOMMENDED OPERATING CONDITIONS (all voltages referenced to GND = 0 V)				
ELECTRICAL PARAMETER	MIN.	TYP.	MAX.	UNIT
PV _{IN} , V _{IN}	4.5	-	20	V
Logic pins	0	-	5.5	
V _{OUT}	0.3	-	5.5	
Drive supply voltage (P _{VCC})	4.75	5	5.25	
Bias supply voltage (V _{DD})	4.75	5	5.25	
Temperature				
Recommended ambient temperature	-40 to +85			°C
Operating junction temperature	-40 to +125			

ELECTRICAL SPECIFICATIONS (PV _{IN} = 12 V, T _J = -40 °C to +125 °C, unless otherwise specified)					
PARAMETER	TEST CONDITIONS	LIMITS			UNIT
		MIN.	TYP.	MAX.	
Power Supplies					
PV _{IN} , V _{IN}		4.5	-	20	V
V _{IN_ON}	Default setting, other settings may be programmed via PMBus	-	10	-	
V _{IN_OFF}	Default setting, other settings may be programmed via PMBus	-	9	-	
PV _{CC} supply	V _{IN} = 4.5 V to 20 V	4.5	5	5.5	
V _{DD} supply	Logic supply voltage	4.5	5	5.5	
PV _{CC} UVLO threshold		3.4	3.6	3.8	
PV _{CC} UVLO hysteresis		-	300	-	
Input current	T _J = 25 °C, non-switching, no load, V _{FB} > 0.5 V, I _{PVCC} + I _{PVDD} + I _{PVIN}	-	-	1	mA
Shutdown current	EN = 0 V, I _{PVCC} + I _{PVDD} + I _{PVIN}	-	-	1	
PV_{IN} Monitoring					
PV _{IN} monitor accuracy		-	5	-	%
PV _{IN} min. monitor resolution		-	70	-	mV
PV _{IN} monitor full scale		-	30	-	V
PV _{IN} read frequency		-	78	-	Hz
PV_{IN} Fault Response Time					
Time to detect faults	OV fault, UV fault (configurable)	-	100	-	ns
Time to set fault registers for faults	OV warn, UV warn	-	78	-	Hz
Output Voltage					
V _{OUT} set-point accuracy	Measured as ΔV (V _{SEN+} - V _{SEN-})	-1	-	1	%
V _{SEN+} + common mode range		-0.2	-	12	V
V _{SEN-} - common mode range		-200	-	+200	mV
V _{OUT} set-point range	(Does not include margining)	0.3	-	12	V
V _{OUT} set-point resolution		-	2	-	mV
Line regulation		-	0.4	-	%
Load regulation		-	0.2	-	
V _{OUT} monitor accuracy	V _{OUT} scale loop = 1	-	-	1	
V _{OUT} min. monitor resolution	V _{OUT} scale loop = 1	-	5	-	mV
V _{OUT} start up delay range	From PV _{IN} valid until 1 st PWM pulse	0	-	127	ms
V _{OUT} read conversion frequency		-	78	-	Hz

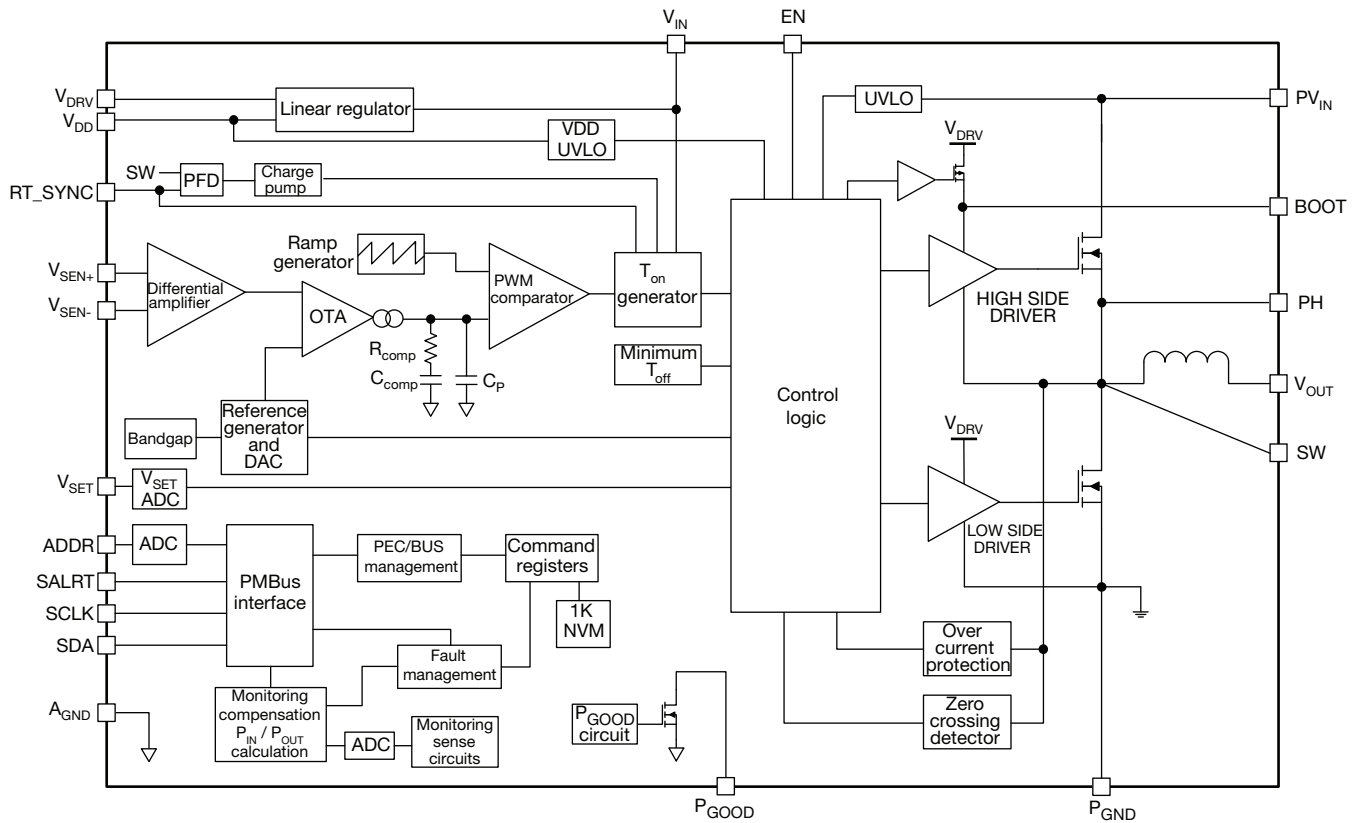

ELECTRICAL SPECIFICATIONS ($PV_{IN} = 12\text{ V}$, $T_J = -40\text{ }^\circ\text{C}$ to $+125\text{ }^\circ\text{C}$, unless otherwise specified)					
PARAMETER	TEST CONDITIONS	LIMITS			UNIT
		MIN.	TYP.	MAX.	
Controller and Timing					
Minimum on-time		-	50	-	ns
t_{ON} accuracy		-10	-	10	%
Frequency accuracy	Default frequency is 600 kHz	540	600	660	kHz
Frequency setting range	CCM mode	300	-	1500	
Minimum off-time		-	250	-	ns
V_{OUT} Soft Start / Soft Stop					
t_{ON_RISE}	From $V_{OUT} = 0\text{ V}$ to V_{OUT} set point	0	-	127	ms
t_{ON_DELAY}	From ON_OFF_CONFIG invoked until V_{OUT} set point	0	-	127	
t_{OFF_FALL}	From the end of the turn-off delay time until the voltage is commanded to zero $I_{OUT_OC_FAULT_LIMIT}$ current must not be exceeded	0	-	127	
t_{OFF_DELAY}	From ON_OFF_CONFIG invoked until $V_{OUT} = 0\text{ V}$	0	-	127	
V_{OUT} Faults					
Time to detect and set fault registers for V_{OUT} faults	OV warn, OV fault, (configurable) (V_{OUT} UV warning and fault has 78 Hz filtering time)	-	100	-	ns
$t_{ON_MAX_FAULT_LIMIT}$	Time to power up the output without reaching the output under voltage fault limit	0	-	127	ms
$t_{OFF_MAX_WARN_LIMIT}$	Time to power down the output without reaching 12.5 % of V_{OUT} set point	0	-	127	
Power Good					
Power good output threshold	V_{OUT} rising (default value, can be changed by PMBus)	-	90	-	%
	V_{OUT} falling (default value, can be changed by PMBus)	-	85	-	
Power good hysteresis	Default rising and falling thresholds	-	5	-	
Power good on resistance		-	5.5	-	Ω
Power good delay time (rising)		-	25	-	μs
Power good delay time (falling)		-	30	-	
Temperature Monitor and Temperature Shutdown					
Resolution		-	1	-	$^\circ\text{C}$
Range		-40	-	150	
Accuracy		-	± 5	-	
Thermal shutdown		-	125	-	
Thermal shutdown hysteresis		-	35	-	
Digital Inputs					
ADDR, SALRT, SCLK, SDA, EN					
V_{IH}	Input high threshold	2	-	-	V
V_{IL}	Input low threshold	-	-	0.8	
V_{HYST}	Input hysteresis	-	0.1	-	
C_{PIN}	Input C	-	5	-	

FUNCTIONAL BLOCK DIAGRAM

Fig. 3 - Functional Block Diagram



PMBus COMMAND								
COMM. CODES	PMBus COMMANDS	COMM. STRUCT.	DESCRIPTION	# DATA BYTES	DEFAULT	DEFAULT VALUE	EXP. (FIXED)	VALID VALUES
0x00	Page			119				
0x01	OPERATION	Byte	Set the operation mode, on / off and margining bit 7 set to 1: ON, 0: OFF bit 6 set to 1: use TOFF_DELAY setting 0: fast turn off bit 5 and 4 output setting 00: VOUT_COMMAND 01: VOUT_MARGIN_LOW 10: VOUT_MARGIN_HIGH 11: AVS (disabled) bit 3 and 2 fault setting, in case VOUT_MARGIN_LOW/HIGH exceed VOUT_OV/UV_FAULT_LIMIT 01: ignore 10: alert according to VOUT_OV/UV_FAULT_RESPONSE bit 0 and 1 NA	1	0x88			
0x02	ON_OFF_CONFIG	Byte	Sets the ON / OFF behavior bit 4 - power up, set to 1: according to OPERATION 0: when power is present bit 3 - PMBUS OPERATION 0: ignore ON / OFF 1: use ON / OFF bit 2 - CONTROL pin 0: ignore CONTROL 1: use CONTROL bit 1 - control pin polarity 0: active low 1: active high bit 0 - turn OFF delay and fall time 0: use settings 1: fast	1	0x1F			
0x03	CLEAR_FAULTS	Send byte	Clears all faults and SMB_ALERT If device is still in fault mode it will alert again does not release from latch condition.	1				
0x10	WRITE_PROTECT	Byte	Set the write protection	1	0x00			
0x15	STORE_USER_ALL	Send byte	Stores all user registers to NVM	1				
0x16	RESTORE_USER_ALL	Send byte	Restores all user registers from NVM	1				
0x19	CAPABILITY	Byte	Sets capabilities of PMBUS bit 7 - PEC 1: enable bit 6 and 5 - bus speed: 10: 1 MHz bit 4 - SMB_ALERT 1: pin available bit 3 - numeric format 0: linear bit 2 - AVSBUS 0: no	1	0xD0			PEC (ON / OFF) SMB_ALERT (ON / OFF)
0x1b	SMBALERT_MASK	Block	SMBALERT mask vectors: NVM / registers 2 bytes - 1 st : STATUS_x command code, 2 nd : mask byte (retrieve mask data is elaborated in spec)	7				



PMBus COMMAND								
COMM. CODES	PMBus COMMANDS	COMM. STRUCT.	DESCRIPTION	# DATA BYTES	DEFAULT	DEFAULT VALUE	EXP. (FIXED)	VALID VALUES
0x20	VOUT_MODE	Byte	Sets V _{OUT} format bit 7 0: absolute 1: relative bit 6 and 5 00: ULINEAR16 / SLINEAR16 01: VID 10: direct 11: IEEE half precision FP bit 4, 3, and 2 ULINEAR16 : N (X = VOUT_COMMANDx2^N) = -9 (10111) VID: VID code type Direct: 00000 IEEE: 00000	1	0x17	-9		
0x21	VOUT_COMMAND	Word	Sets V _{OUT} (V) 2 bytes SLINEAR16	2	0x0133	0.6	-9	0.3-14
0x22	VOUT_TRIM	Word	User trimming offset to be added in SLINEAR16 format (2's complement) (V) 2 bytes SLINEAR16	2	0x0000	0	-9	(-2)-2
0x24	VOUT_MAX		Sets maximum V _{OUT} for alert and limiting V _{OUT} (V) 2 bytes SLINEAR16	2	0x1C00	14	-9	0.3-14
0x25	VOUT_MARGIN_HIGH	Word	5 % Set the MARGIN HIGH voltage 2 bytes SLINEAR16	2	0x0142	0.63	-9	0.3-14
0x26	VOUT_MARGIN_LOW	Word	-5 % Set the MARGIN LOW voltage 2 bytes SLINEAR16 11	2	0x0123	0.57	-9	0.3-14
0x27	VOUT_TRANSITION_RATE	Word	Sets the slew rate in mV/μs 2 bytes ULINEAR11	2	0xE002	0.125	-4	0.0625-2
0x29	VOUT_SCALE_LOOP	Word	Sets the V _{OUT} /FB ratio 2 bytes SLINEAR11, 0.125,0.25, 0.5, 1 allowed	2	0xE808	1	-3	0.125, 0.25, 0.5, 1
0x33	FREQUENCY_SWITCH	Word	Switching frequency: (kHz) 2 bytes LINEAR11, (200K to 1500K, 50K steps)	2	0x0258	600	0	300K to 1500K, 50K steps
0x35	VIN_ON	Word	V _{IN} in which the device starts 2 bytes SLINEAR11	2	0xF814	10	-1	1-80
0x36	VIN_OFF	Word	V _{IN} in which the device stops 2 bytes SLINEAR11	2	0xF812	9	-1	1-80
0x37	Interleave	Word	Set master / slave clock 0° or 180° out of phase. See INTERLEAVE description for detail	2	0x0000	0		See INTERLEAVE description
0x40	VOUT_OV_FAULT_LIMIT	Word	Sets the OVP DAC level above V _{OUT} in digital mode Default analog = 115 % V _{OUT} 2 bytes SLINEAR16	2	0x0161	0.69	-9	0.3-14
0x41	VOUT_OV_FAULT_RESPONSE	Word	Bit 7, 6 to 11: shut down until fault is disabled bit 3, 4, and 5 - 111: restart continuously bit 0, 1, and 2 - 000: no delay	1	0xF8	According to settings		All
0x42	VOUT_OV_WARN_LIMIT	Word	Telemetry warn limit (V) 2 bytes SLINEAR16	2	0x0151	0.66	-9	0.3-14
0x43	VOUT_UV_WARN_LIMIT	Word	Telemetry warn limit (V) 2 bytes SLINEAR16	2	0x0114	0.54	-9	0-14



PMBus COMMAND								
COMM. CODES	PMBus COMMANDS	COMM. STRUCT.	DESCRIPTION	# DATA BYTES	DEFAULT	DEFAULT VALUE	EXP. (FIXED)	VALID VALUES
0x44	VOUT_UV_FAULT_LIMIT	Word	Sets the UVP in digital mode (V) Default analog = 20 % V _{OUT} 2 bytes SLINEAR16	2	0x00F5	0.48	-9	0-14
0x45	VOUT_UV_FAULT_RESPONSE	Byte	Bit 7 and 6 - 10: shut down with hiccup bit 3, 4, and 5 - 111: restart continuously bit 0, 1, and 2 - 001: delay 20 ms	1	0xB9	According to settings		All
0x46	IOUT_OC_FAULT_LIMIT	Word	Cycle by cycle temperature compensated OCP detector (A) 2 bytes LINEAR11 exp. -1	2	0xF83C	30	-1	0-127
0x47	IOUT_OC_FAULT_RESPONSE	Byte	Bit 7 and 6 - 10: Continue for number of pulses set by event count than hiccup forever bit 3, 4, and 5 - 100: 128 OCP counts bit 0, 1, and 2 - 001: delay 20 ms	1	0xA1	According to settings		All
0x4f	OT_FAULT_LIMIT	Word	Over temperature limit (°C), 35 °C hysteresis 2 bytes LINEAR11 exp. -1	2	0x007D	125	0	0-150
0x50	OT_FAULT_RESPONSE	Byte	Bit 7 and 6 - 10: shut down with hiccup bit 3, 4, and 5 - 111: restart continuously bit 0, 1, and 2 - 001: delay 20 ms	1	0xB9	According to settings		All
0x51	OT_WARN_LIMIT	Word	Telemetry warn limit (°C) 2 bytes LINEAR11 exp. 0	2	0x0069	105	0	0-150
0x55	VIN_OV_FAULT_LIMIT	Word	V _{IN} OV fault limit (V) 2 bytes LINEAR11	2	0xF81E	15	-1	1-80
0x56	VIN_OV_FAULT_RESPONSE	Byte	Bit 7 and 6 - 10: shut down with hiccup bit 3, 4 and 5 - 111: restart continuously bit 0, 1, and 2 - 000: no delay	1	0xB8	According to settings		All
0x58	VIN_UV_WARN_LIMIT	Word	Telemetry warn limit (V) 2 bytes LINEAR11	2	0xF812	9	-1	1-80
0x5e	POWER_GOOD_ON	Word	POWER GOOD high threshold (V) 2 bytes SLINEAR16	2	0x0123	0.57	-9	0.24-14
0x5F	POWER_GOOD_OFF	Word	POWER GOOD low threshold (V) 2 bytes SLINEAR16	2	0x0114	0.54	-9	0.24-14
0x60	TON_DELAY	Word	Delay from ON (ms) 2 bytes LINEAR11	2	0x0000	0	0	0-127
0x61	TON_RISE	Word	Rise time (ms) 2 bytes LINEAR11	2	0x0005	5	0	0-127
0x62	TON_MAX_FAULT_LIMIT	Word	Time until UV/PGOOD is reached (ms) Selectable by MFR_OP_MODE 2 bytes LINEAR11	2	0x0014	20	0	0-127
0x63	TON_MAX_FAULT_RESPONSE	Byte	Bit 7 and 6 - 10: shut down with hiccup bit 3, 4, and 5 - 000: no restart until faults cleared by user (latched) bit 0, 1, and 2 - 001: delay 20 ms	1	0x81	Shutdown until fault is disabled		Shutdown / shutdown until fault is disabled
0x64	TOFF_DELAY	Word	Delay from OFF (ms) 2 bytes LINEAR11	2	0x0000	0	0	0-127



PMBus COMMAND								
COMM. CODES	PMBus COMMANDS	COMM. STRUCT.	DESCRIPTION	# DATA BYTES	DEFAULT	DEFAULT VALUE	EXP. (FIXED)	VALID VALUES
0x65	TOFF_FALL	Word	Fall time (ms) 2 bytes LINEAR11	2	0x0005	5	0	0-127
0x66	TOFF_MAX_WARN_LIMIT	Word	Time until 12.5 % is reached (ms) 2 bytes LINEAR11	2	0x003C	60	0	0-127
0x78	STATUS_BYTE	Byte	1 byte	1				
0x79	STATUS_WORD	Word	2 bytes	1				
0x7a	STATUS_VOUT	Byte	1 byte	1				
0x7b	STATUS_IOUT	Byte	1 byte	1				
0x7c	STATUS_INPUT	Byte	1 byte	1				
0x7d	STATUS_TEMPERATURE	Byte	1 byte	1				
0x7e	STATUS_CML	Byte	1 byte	1				
0x80	STATUS_MFR_SPECIFIC	Byte		1				
0x88	READ_VIN	Word	V _{IN} (V) 2 bytes LINEAR11	2			-4	0-80
0x8b	READ_VOUT	Word	V _{OUT} (V) 2 bytes LINEAR16	2			-9	0-48
0x8d	READ_TEMPERATURE	Word	Temperature (°C) 2 bytes ULINEAR11	2			0	(-50)-150
0x94	READ_DUTY_CYCLE	Word	Duty-cycle (t _{on} / t _{on} + t _{off}) (%) 2 bytes LINEAR11	2			-4	0-100
0x98	PMBUS_REVISION	Byte	1 byte	1	0x33			
0x99	MFR_ID	Block	3 bytes	3	0x00			
0x9a	MFR_MODEL	Block	2 bytes	2	0x00			
0x9b	MFR_REVISION	Block	2 bytes	2	0x00			
0x9e	MFR_SERIAL	Block		2				
0xad	IC_DEVICE_ID	Block	2 bytes	2	0x00			
0xae	IC_DEVICE_REV	Block	2 bytes	2	0x00			

OPERATIONAL DESCRIPTION

Device Overview

SiC951 is a high efficiency synchronous buck regulator capable of delivering up to 25 A continuous current. The device has programmable switching frequency of 300 kHz to 1.5 MHz. The control scheme delivers fast transient response and minimizes external components. Thanks to the internal current ramp information, no high ESR output bulk or virtual ESR network is required for the loop stability. This device also incorporates a power saving feature by enabling diode emulation mode and frequency fold back as the load decreases.

In addition, a built in PLL allows in phase or 180° out of phase synchronization under master / slave configuration.

SiC951 has a full set of protection and monitoring features with response that can be set with PMBus:

- Over current protection in pulse-by-pulse mode
- Output over voltage protection
- Output under voltage protection
- Over temperature protection with hysteresis
- Dedicated enable pin for easy power sequencing
- Power good open drain output

This device is available in MLP59-A6C package to deliver high power density and minimize PCB area.

PWM Control Mechanism

SiC951 employs a voltage - mode COT control mechanism. During steady-state operation, feedback voltage is compared with internal reference and the amplified error signal (V_{COMP}) is generated in the internal comp node. An internally generated ramp signal and V_{COMP} are fed into a comparator. Once V_{RAMP} crosses V_{COMP} , a single shot on-time pulse is generated for a fixed time, programmed by the external R_{FSW} . During the on-time pulse, the high side MOSFET will be turned on. Once the on-time pulse expires, the low side MOSFET will be turned on after a break-before-make period. The low side MOSFET will be on for duration of minimum off-time pulse until V_{RAMP} crosses V_{COMP} . The cycle is then repeated.

Fig. 4 illustrates the basic block diagram for VM-COT architecture. In this architecture the following is achieved:

- The reference of a basic ripple control regulator is replaced with a high gain error amplifier loop
- This establishes two parallel voltage regulating feedback paths, a fast and slow path
- Fast path is the ripple injection which ensures rapid correction of the transient perturbation
- Slow path is the error amplifier loop which ensures the DC component of the output voltage follows the internal accurate reference voltage

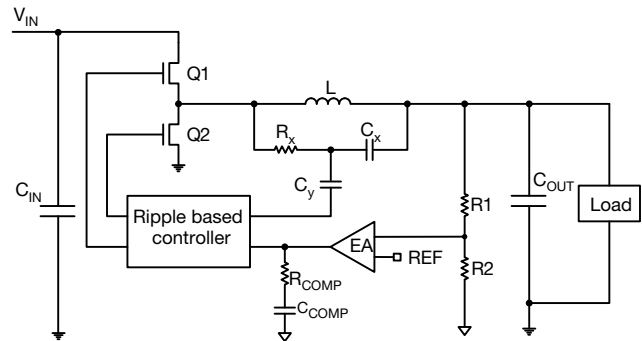

Fig. 4 - VM-COT Block Diagram

Note

- Control loop representation only, for simplicity remote sensing and output voltage setting not shown

All components for RAMP signal generation and error amplifier compensation required for the control loop are internal to the IC, see Fig. 4. In order for the device to cover a wide range of V_{OUT} operation, the internal RAMP signal components (R_x , C_x , C_y) are automatically selected depending on the V_{OUT} voltage and switching frequency. This method allows the RAMP amplitude to remain constant throughout the V_{OUT} voltage range, achieving low jitter and fast transient response. The error amplifier internal compensation consists of a resistor in series with a capacitor (R_{COMP} , C_{COMP}).

Fig. 5 demonstrates the basic operational waveforms:

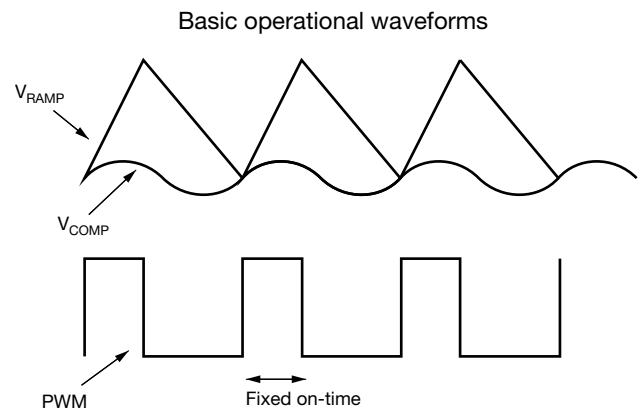

Fig. 5 - VM-COT Operational Principle

Light Load Condition

To improve efficiency at light-load condition, SiC951 provide a set of innovative implementations to eliminate LS recirculating current and switching losses. The internal zero crossing detector monitors SW node voltage to determine when inductor current starts to flow negatively. In power saving mode, as soon as inductor valley current crosses zero, the device deploys diode emulation mode by turning off low side MOSFET. If load further decreases, switching frequency is reduced proportional to load condition to save switching losses while keeping output ripple within tolerance. The switching frequency is set by the controller to maintain regulation. In the standard power save mode, there is no minimum switching frequency. If ultrasonic mode is selected via PMBus, the minimum switching frequency that the regulator will reduce to is > 20 kHz as the part avoids switching frequencies in the audible range.

Power Stage

SiC951 integrates a high performance power stage with a 4 mΩ n-channel high side MOSFET and a 1.4 mΩ n-channel low side MOSFET. The MOSFETs are optimized to achieve up to 96 % efficiency.

The power input voltage (PV_{IN}) can go up to 20 V and down as low as 4.5 V. The output voltage must always be less than the input voltage.

Sequencing of Input / Output Supplies

SiC951 has no sequencing requirements on any of its input / output, PV_{IN} , PV_{CC} , V_{IN} , V_{DD} and EN.

EN

The SiC951 has an EN pin to turn the part on and off. Driving this pin high enables the device, while grounding it turns it off.

There are no sequencing requirements with respect to input / output supplies.

Output Over-Current Protection (OCP)

SiC951 has pulse-by-pulse over-current limit control. The inductor valley current is monitored during LS FET turn-on period through $R_{DS(on)}$ sensing. After a pre-defined blanking time, the valley current is compared with internal threshold to determine the over current limit threshold. This threshold can be programmed via PMBus. Default value is 30 A. If monitored current is higher than OCP threshold, HS turn-on pulse is skipped and LS FET is kept on until the valley current returns below OCP limit.

If the OCP persists for more than 128 consecutive cycles, the device latches off and stays off until the fault is cleared. OCP is enabled immediately after V_{CC} passes UVLO level.

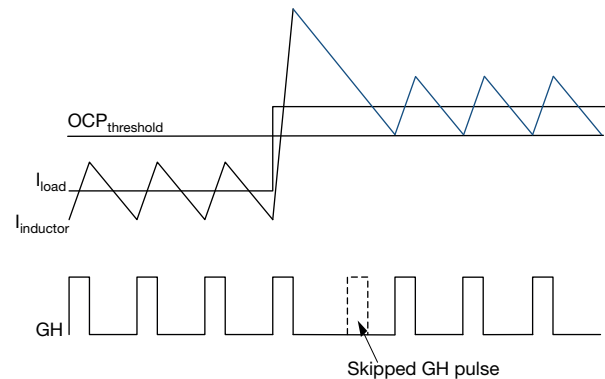

Fig. 6 - Over-Current Protection Illustration

Output Under-Voltage Protection (UVP)

UVP is implemented by monitoring the output voltage. If the output voltage drops below the target V_{OUT} by more than 20 %, the UVP event is recognized and both HS and LS MOSFETs are turned off. The fault must be cleared before the device can be restarted. Other fault responses may be programmed via PMBus (see PMBus command section).

UVP is only active after the completion of soft-start sequence.

Output Over-Voltage Protection (OVP)

For OVP implementation, output is monitored through FB pin. After soft start, if the voltage level at FB is above 15 %, OVP is triggered with both the HS and LS MOSFETs turned off. The part can be re-started by cycling the EN pin or PV_{IN} supplies.

OVP is active immediately after V_{CC} passes UVLO level.

Over-Temperature Protection (OTP)

SiC951 has internal thermal monitor block that turns off both HS and LS FETs when junction temperature is above 125 °C. The default PMBus setting for an OTP condition is for the device to stay off until the fault is cleared.

In case a retry is programmed via PMBus, a hysteresis of 35 °C is implemented, so when junction temperature drops below 90 °C, the device restarts by initiating soft-start sequence again.

Pre-Bias Start-Up

In case of pre-bias start up, output is monitored through FB pin. If the sensed voltage on FB is higher than the internal reference ramp value, control logic prevents HS and LS FET from switching to avoid negative output voltage spike and excessive current sinking through LS FET.

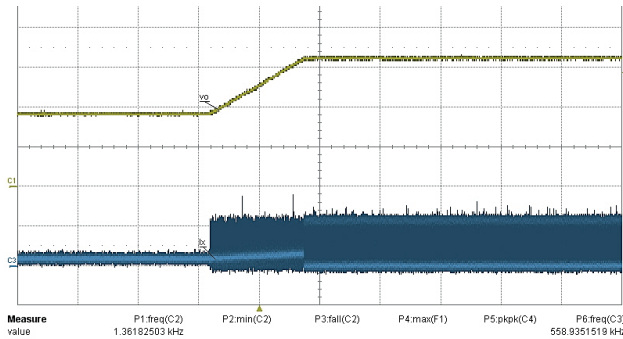
Fig. 7 - Pre-Bias Start-Up

Output Voltage Setting

Output voltage (V_{OUT}) can be set by connecting a resistor from V_{SET} to A_{GND} . The resistor setting can be over-riden by a PMBus command. See below table for the list of output voltage (V_{OUT}) set by the V_{SET} resistor value.

OUTPUT VOLTAGE SETTING	
V_{SET} RESISTOR (k Ω)	V_{OUT} (V)
0.845	0.60
1.3	0.90
1.78	0.95
2.32	1.00
2.87	1.05
3.48	1.20
4.12	1.25
4.75	1.50
5.49	1.80
6.19	2.10
6.98	2.50
7.87	3.30
8.87	5.00
10	5.00
11	12
12.1	0.60
Short	0.60

A missing or shorted resistor results in the part turning on with the minimum output voltage of 0.6 V. This allows for easy system debug.

RT / SYNC PIN and Interleave Function Operation

The SiC951 has an RT / SYNC pin. This pin can be used to set the switching frequency and to send / receive a clock signal for synchronization between a master / slave. Connecting a resistor to ground will set the switching frequency according to the table listed below. If no resistor is connected to the RT / SYNC pin, the part will operate at the default frequency of 600 kHz. The default frequency as well as the frequency set by the external resistor, can be overridden by a PMBus command to a different operating frequency.

The following table shows the frequency settings by the RT resistor value.

FREQUENCY SETTINGS	
RT RESISTOR (k Ω)	FREQUENCY (kHz)
0.845	300
1.3	400
1.78	500
2.32	550
2.87	600
3.48	650
4.12	700
4.75	750
5.49	800
6.19	850
6.98	900
7.87	950
8.87	1000
10	1250
11	1500
12.1 (open)	600
Short	600

SiC951 supports in phase or 180° out of phase synchronization. There are 3 modes of configuration via PMBus.

1. Master

- Mode of operation: determined by PMBus. As a master, it sends its internal clock out onto the RT / SYNC pin
- Operating frequency: frequency can either be the default frequency or programmed frequency via PMBus. If a part is designated as a master, switching frequency cannot be set using an external resistor. A clock signal will be sent via the RT / SYNC pin to the slave

2. Slave

- Mode of operation: determined by PMBus. As a slave, the unit synchronizes its internal clock frequency either in phase or 180° out of phase as selected via the PMBus to the incoming clock applied at its RT / SYNC pin
- Operating frequency: the slave switching frequency will synchronize to the external clock or to the master clock. In case the external clock or master clock signal is lost, the slave will operate at the default frequency or to the frequency programmed via the PMBus; see Fig. 8.

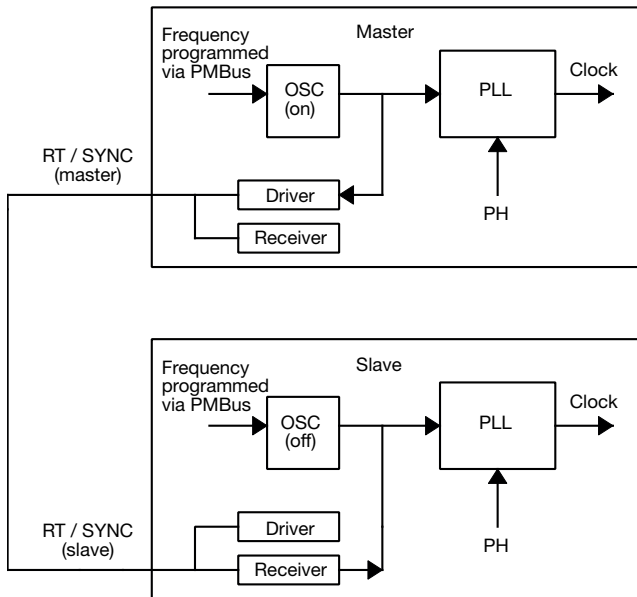

Fig. 8

If the user decides not to set the frequency of the slave via PMBus and also wants to have a frequency other than the default frequency, it is possible to program this by connecting a resistor between RT / SYNC and A_{GND}. Additional component, diode and capacitor will be needed. This is illustrated in the Fig. 9:

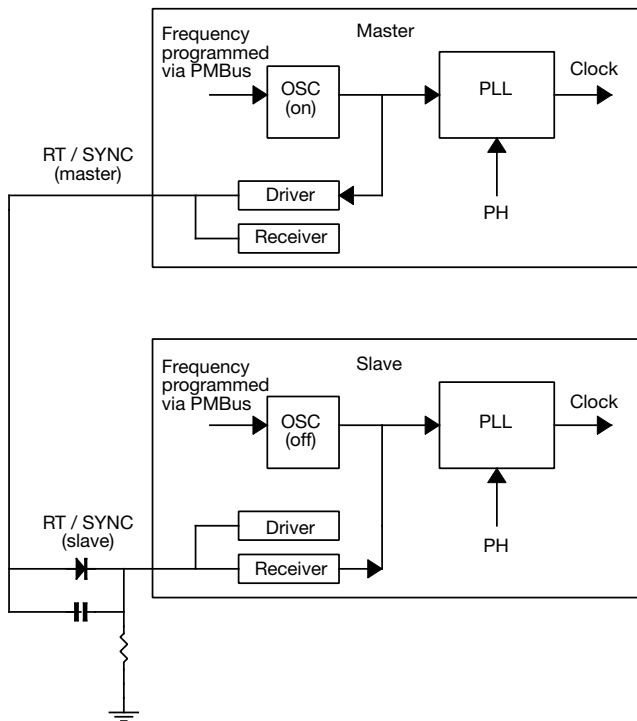

Fig. 9

3. Standalone Operation

- Mode of operation: determined by PMBus. The unit is neither master nor slave. It does not drive the RT / SYNC pin and it ignores any clock on RT / SYNC pin.
- Switching frequency: in standalone operation, the part will either operate at the default frequency of 600 kHz or at the frequency programmed by a resistor, both of which can be overridden by a PMBus command

In order to configure the part as a master, slave or standalone operation, the interleave will be used. The interleave command data bytes include three pieces of information:

1. A group identification number (4 bits)
2. The number of units in the group (4 bits)
3. The interleave order for this particular unit (4 bits). This number ranges in value from zero to one less than the number of units in the group

The group identification number allows for up to fifteen groups. Group Identification number 0 is reserved to mean not a member of an interleaved group. If the group identification number is 0, then the number of units in the group and the interleave order shall also be 0.

BYTE	HIGH BYTE				LOW BYTE											
	Bit Number	7	6	5	4	3	2	1	0	7	6	5	4	3	2	1
Contents	Not used		Group ID number		Number in group		Interleave order									
Default value	00		00		00		00									

- Standalone
 GROUP ID = 0
 Number of units = 0
 Interleave order = 0 (0000 0000 0000 0000)
- Master
 GROUP ID = 1
 Number of units = 0
 Interleave order = 0 (0000 0001 0000 0000)
- Slave (in phase)
 GROUP ID = 1
 Number of units = 2
 Interleave order = 0 (0000 0001 0010 0000)
- Slave (180° out of phase)
 GROUP ID = 1
 Number of units = 2
 Interleave order = 1 (0000 0001 0010 0001)

All other combinations are invalid.

The default state can either be “standalone” or one of the two “slave” modes (it cannot be master because un-programmed units would both try to send their clock on the same SYNC line).



PMBus ADDRESS (ADDR Pin)

The SiC951 has a 7-bit register that are used to set the base PMBus address of the device. A resistor may be connected between the ADDR and A_{GND} pins to set an offset from the default pre-configured MFR base address in the memory. Up to 16 different offsets can be set allowing 16 SiC951 devices with unique addresses in a single system. This offset and therefore the device address is read by the ADC during the initialization sequence. The table below provides the resistor values needed to set the 16 offsets from the base address:

A missing or shorted resistor results in the part turning on with the default PMBus settings and output voltage based on the V_{SET} resistor. This allows for easy system debug.

Note

- The ADDR resistor will set the initial position of the MFR_BASE_ADDRESS (see PMBus command table)

WRITE			
CONNECTION	ADDRESS	HEX	BIN
Short / open	0	1E	00011110
0.845K	1	20	00100000
1.3K	2	22	00100010
1.78K	3	24	00100100
2.32k	4	26	00100110
2.87K	5	28	00101000
3.48K	6	2A	00101010
4.12K	7	2C	00101100
4.75K	8	2E	00101110
5.49K	9	30	00110000
6.19K	10	32	00110010
6.98K	11	34	00110100
7.87K	12	36	00110110
8.87K	13	38	00111000
10K	14	3A	00111010
11K	15	3C	00111100

READ			
CONNECTION	ADDRESS	HEX	BIN
Short / open	0	1F	00011111
0.845K	1	21	00100001
1.3K	2	23	00100011
1.78K	3	25	00100101
2.32k	4	27	00100111
2.87K	5	29	00101001
3.48K	6	2B	00101011
4.12K	7	2D	00101101
4.75K	8	2F	00101111
5.49K	9	31	00110001
6.19K	10	33	00110011
6.98K	11	35	00110101
7.87K	12	37	00110111
8.87K	13	39	00111001
10K	14	3B	00111011
11K	15	3D	00111101

ELECTRICAL CHARACTERISTICS ($V_{IN} = 12\text{ V}$, $V_{OUT} = 1.2\text{ V}$, $f_{SW} = 600\text{ kHz}$, SiC951 (25 A), $C_{IN} = 2.2\text{ }\mu\text{F} \times 3$, $C_{OUT} = 47\text{ }\mu\text{F} \times 12$, unless otherwise noted)

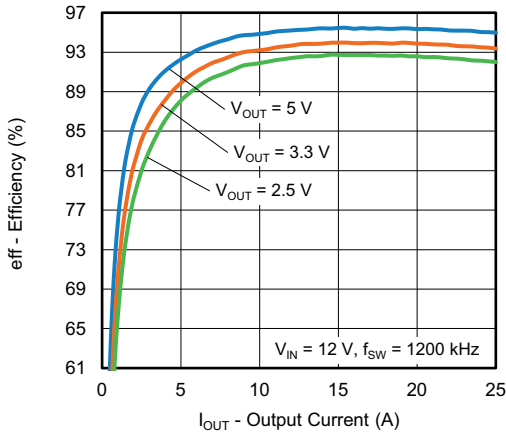

Fig. 10 - Efficiency vs. Output Current

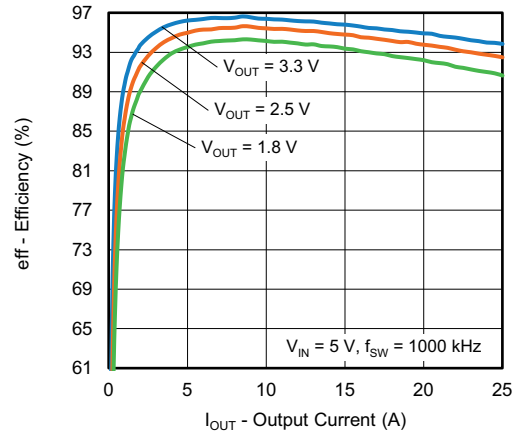

Fig. 13 - Efficiency vs. Output Current

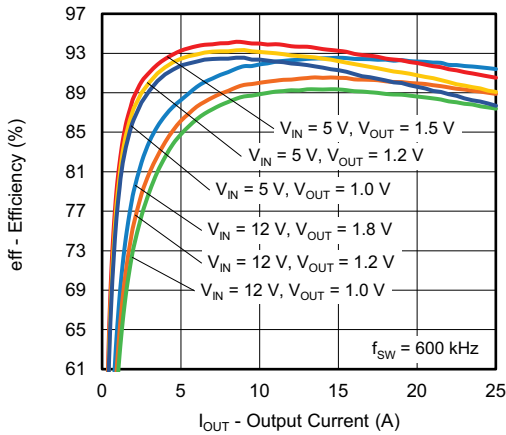

Fig. 11 - Efficiency vs. Output Current

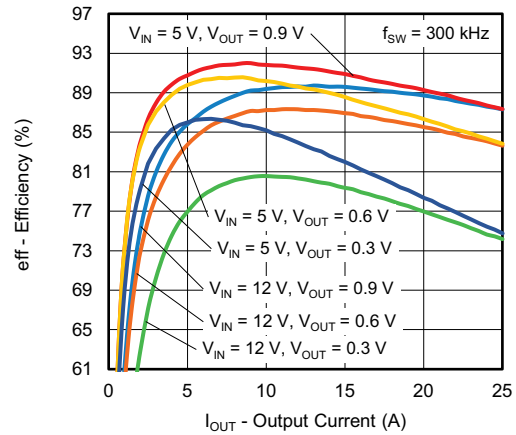

Fig. 14 - Efficiency vs. Output Current

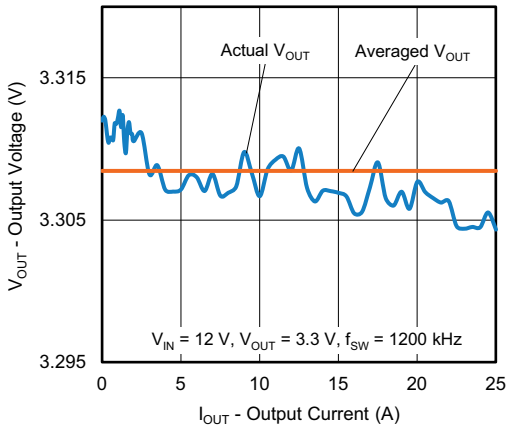

Fig. 12 - Load Regulation, $V_O = 3.3\text{ V}$

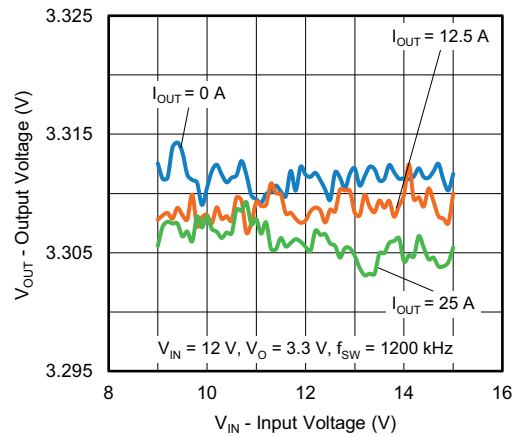

Fig. 15 - Line Regulation, $V_O = 3.3\text{ V}$

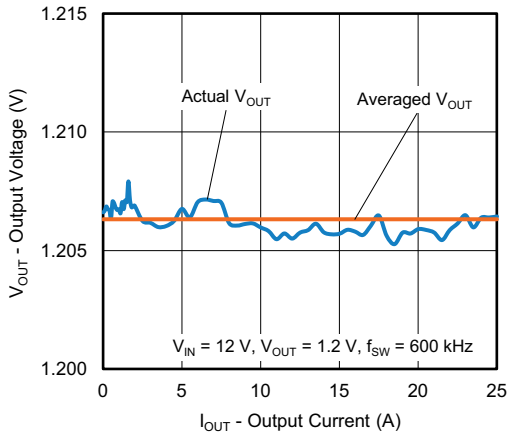

Fig. 16 - Load Regulation, $V_O = 1.2\text{ V}$

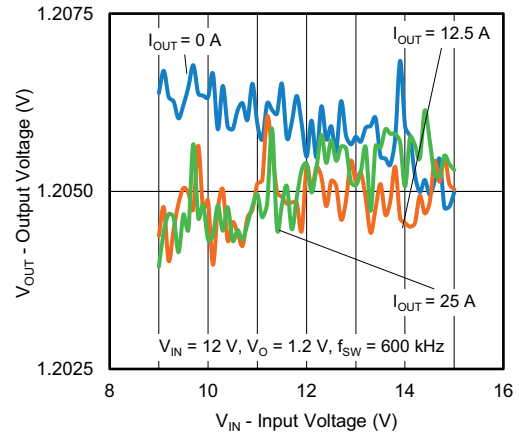

Fig. 17 - Line Regulation, $V_O = 1.2\text{ V}$

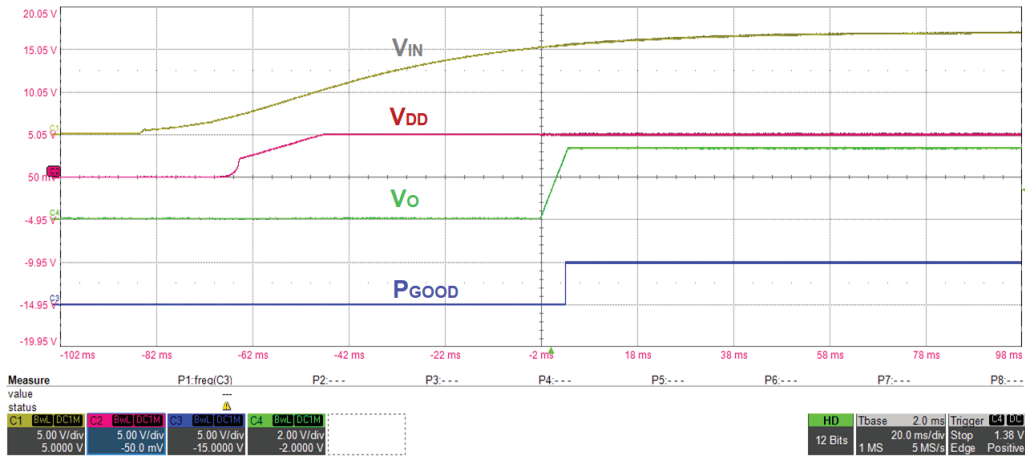

Fig. 18 - Startup With V_{IN} , no load

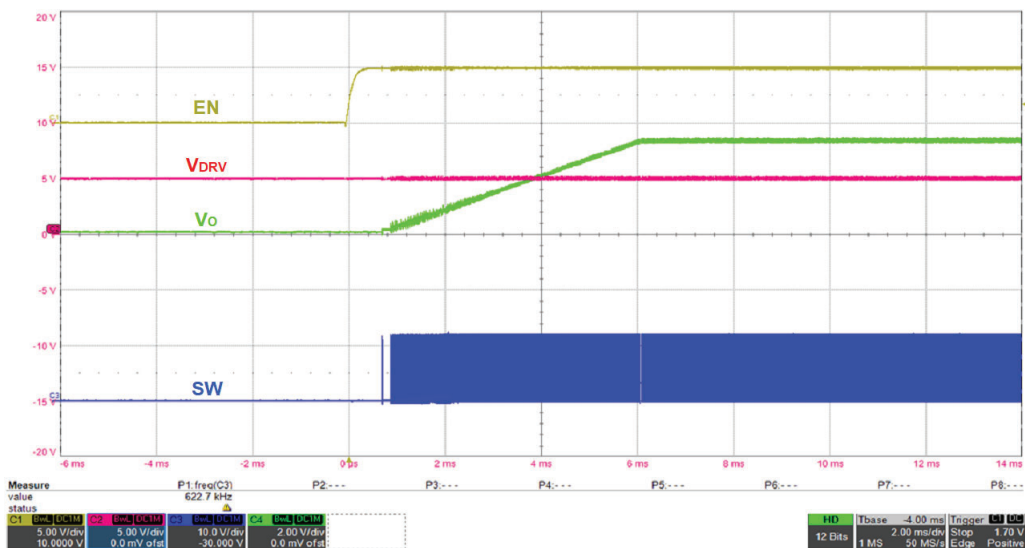

Fig. 19 - Startup With EN, no load

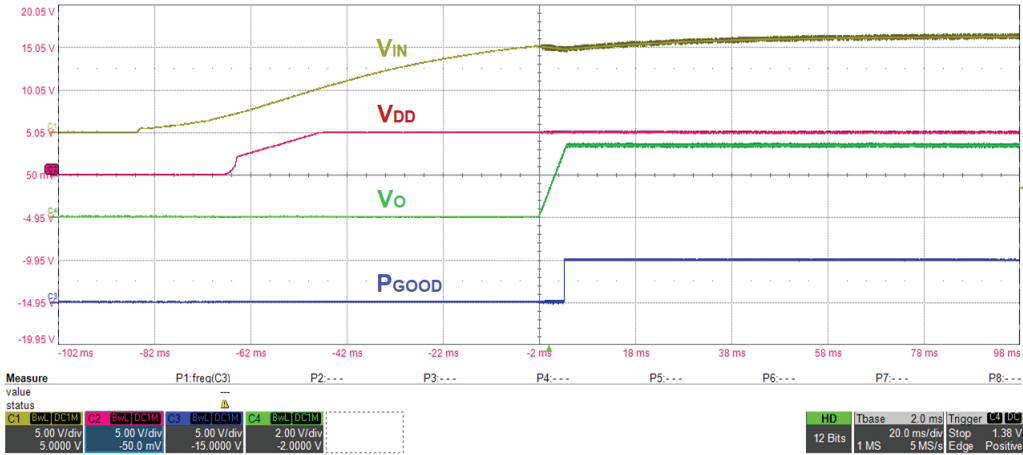

Fig. 20 - Startup With V_{IN} , 25 A load

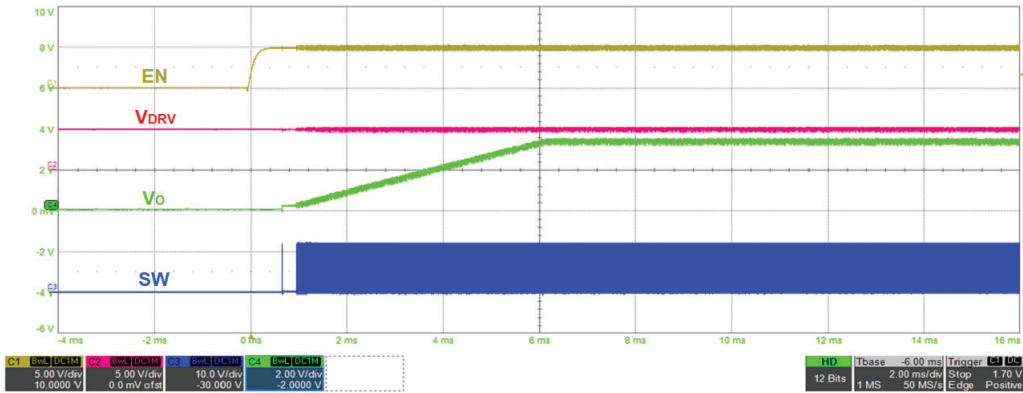

Fig. 21 - Startup with EN, 25 A load

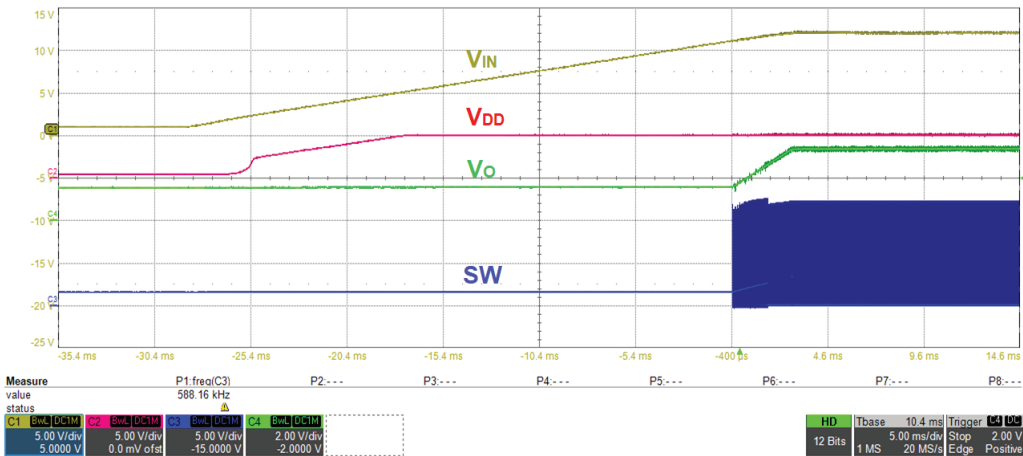

Fig. 22 - Startup With V_{IN} , no load, 1.5 V V_O pre-bias

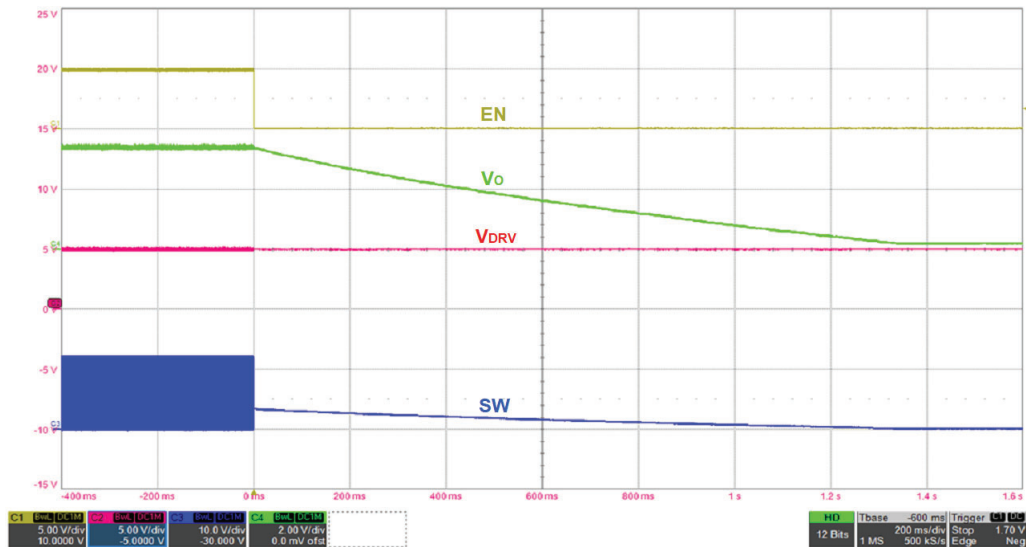

Fig. 23 - Shutdown with EN, no load

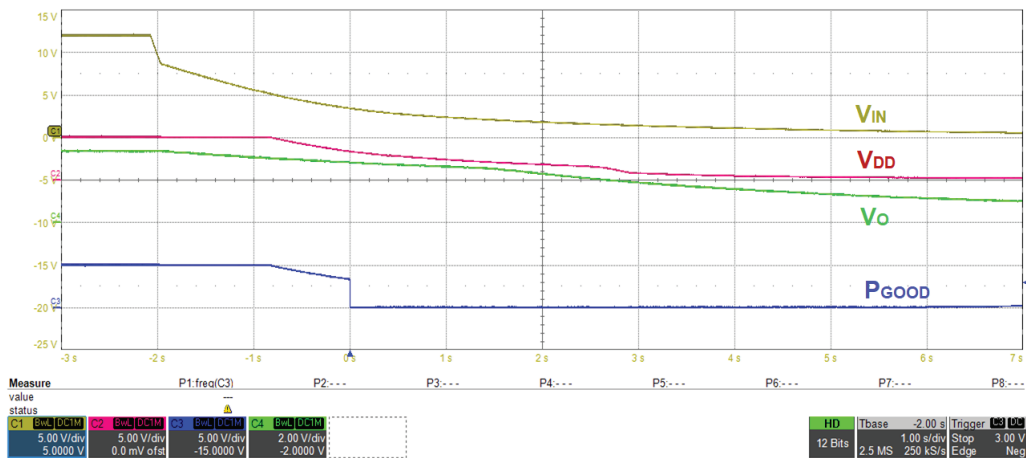

Fig. 24 - Shutdown with VIN, no load

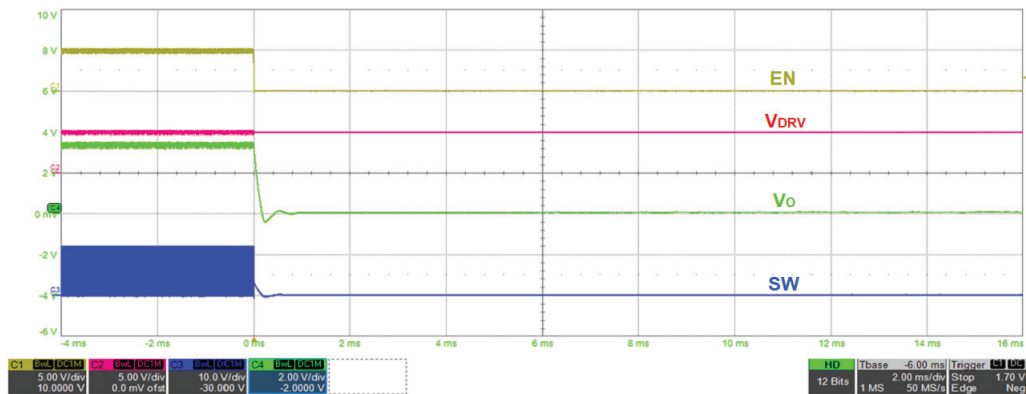

Fig. 25 - Shutdown with EN, 25 A load

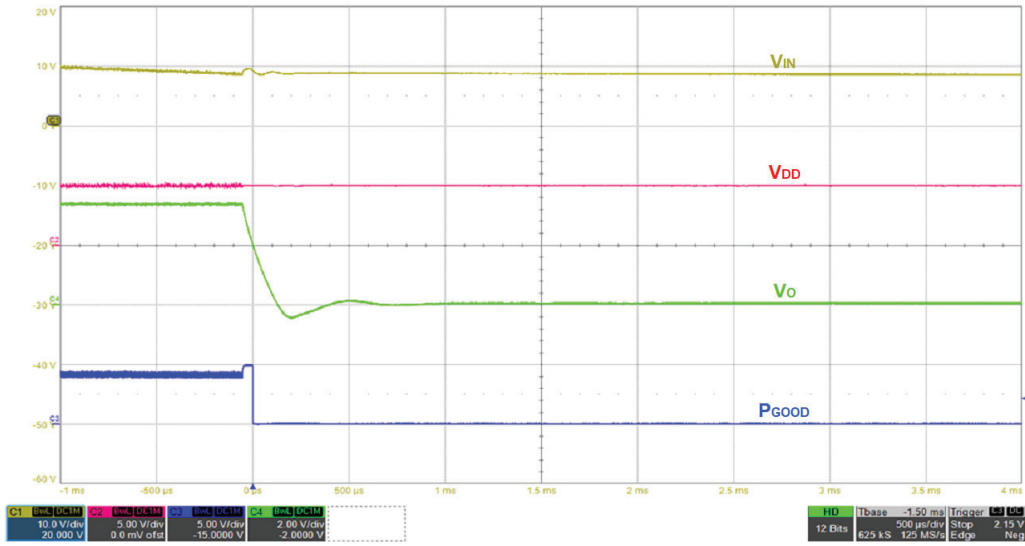

Fig. 26 - Shutdown with V_{IN} , 25 A load

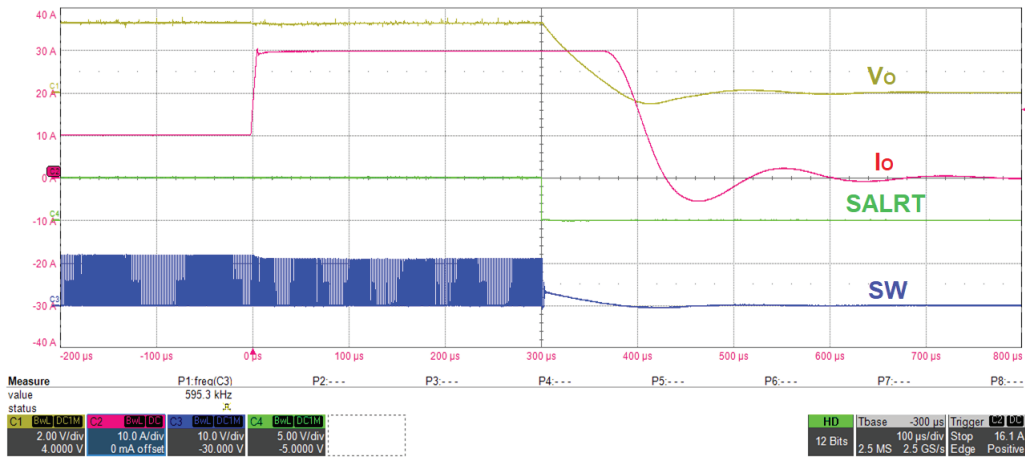

Fig. 27 - OCP

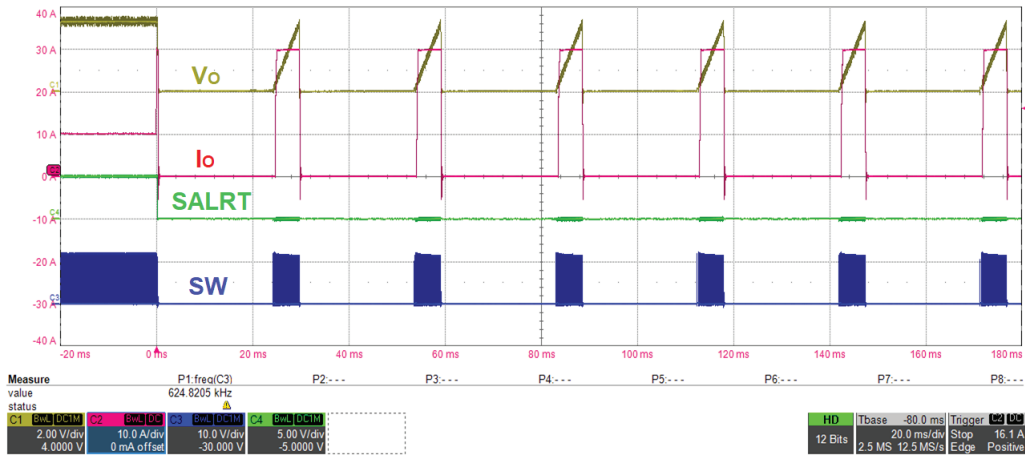

Fig. 28 - OCP

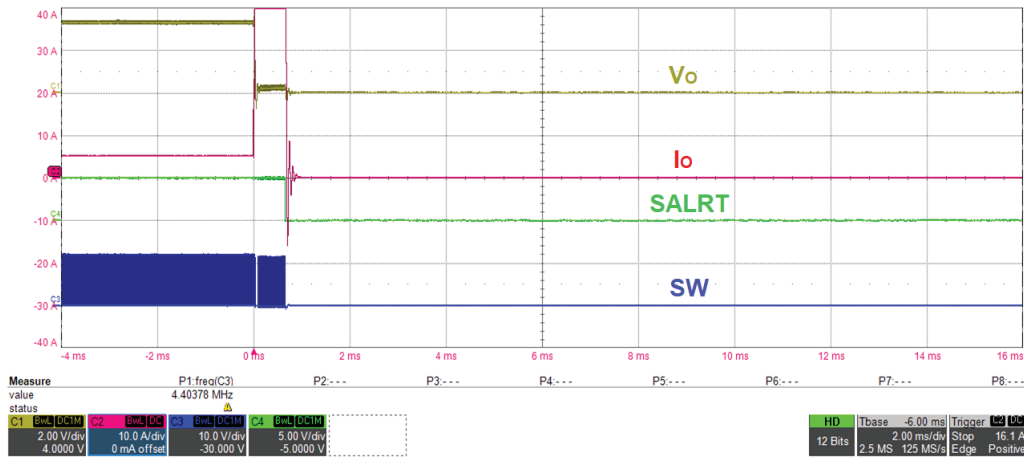

Fig. 29 - SCP

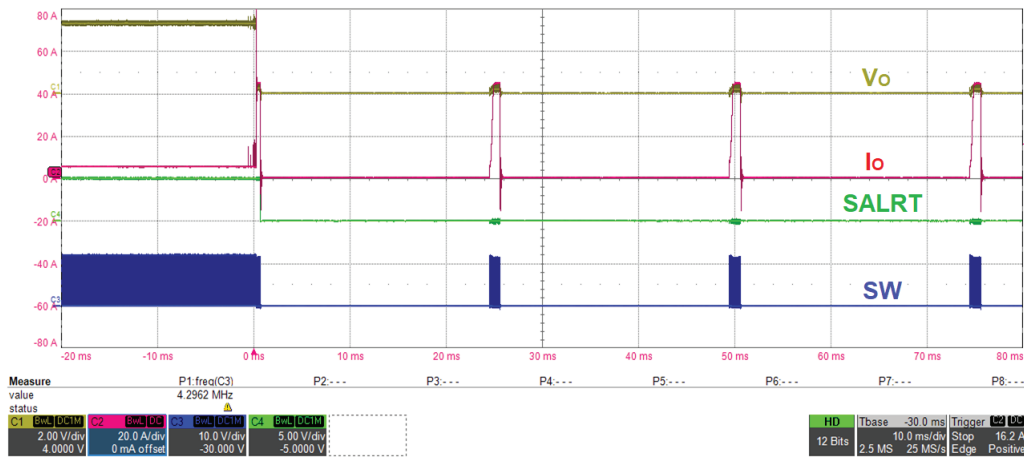

Fig. 30 - SCP

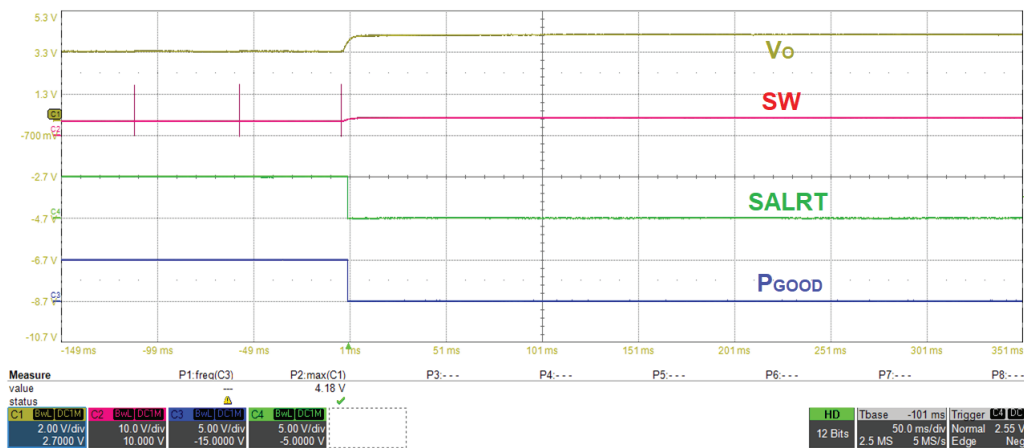
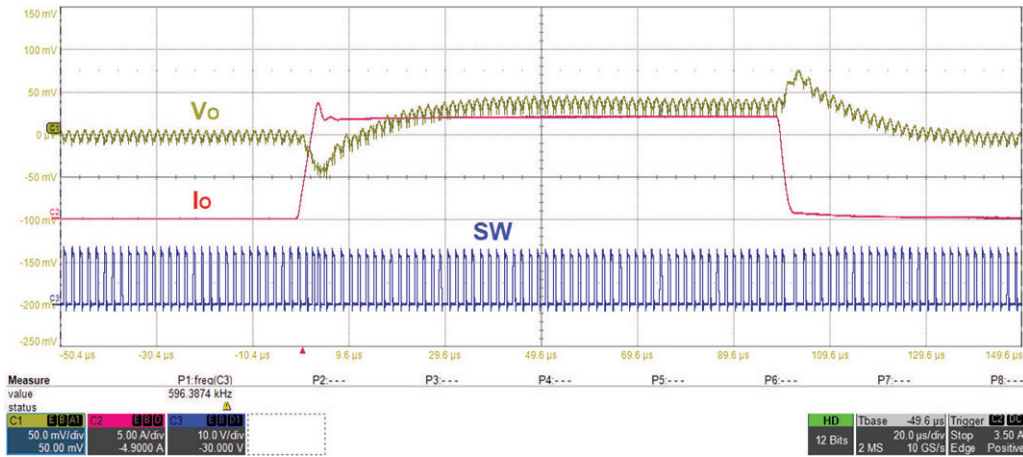
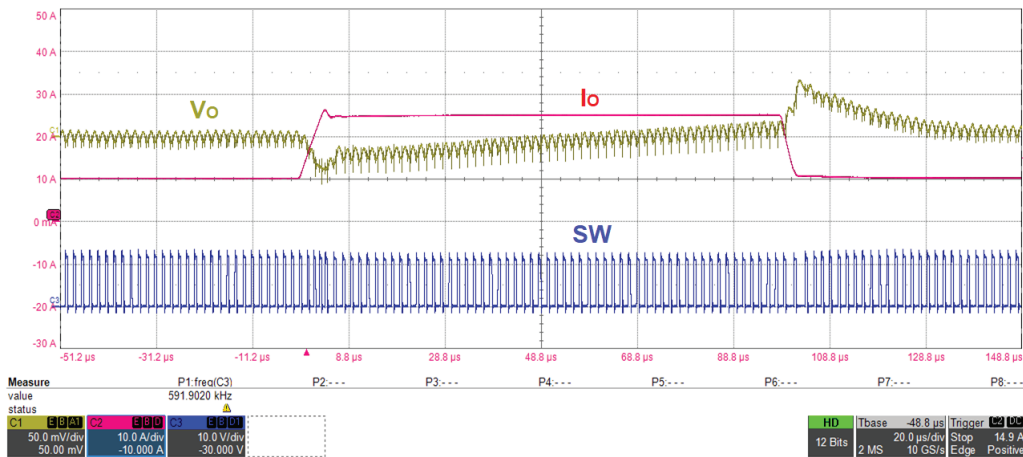
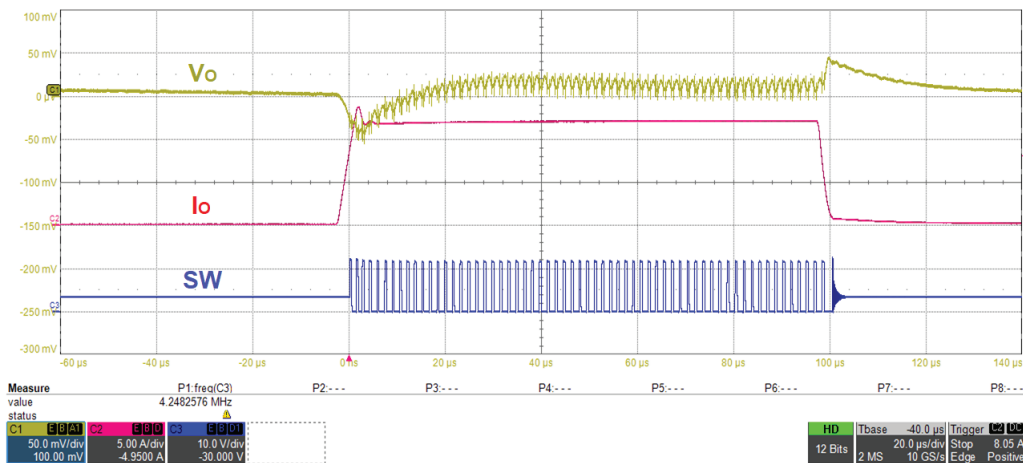

Fig. 31 - OVP

Fig. 32 - Load step, 0 A to 12 A to 0 A, CCM

Fig. 33 - Load step, 10 A to 25 A to 10 A

Fig. 34 - Load step, 0 A to 12 A to 0 A, PSM

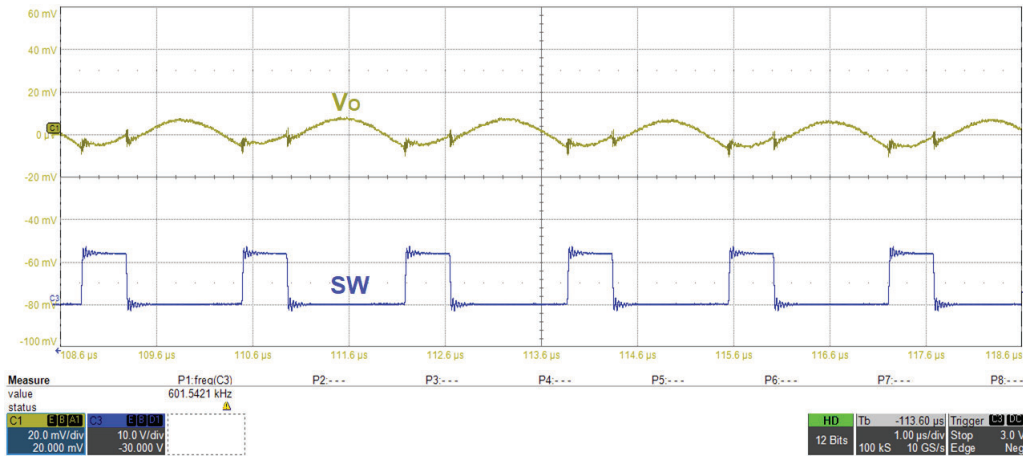

Fig. 35 - Output Ripple at no load, CCM

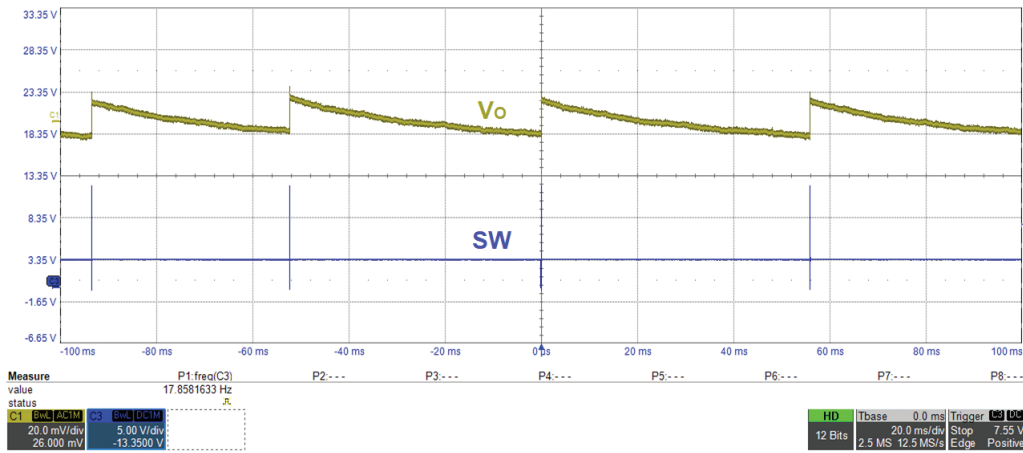

Fig. 36 - Output Ripple at no load, PSM

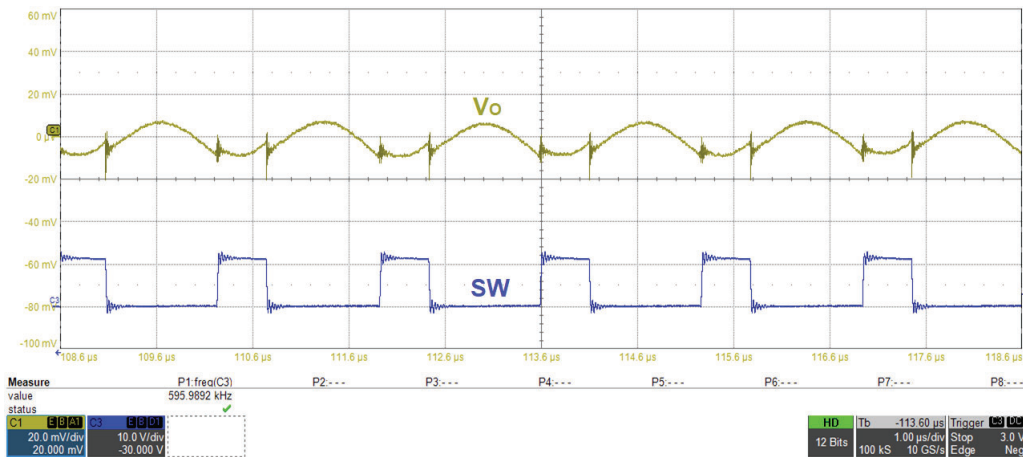

Fig. 37 - Output Ripple at 25 A



PRODUCT SUMMARY	
Part number	SiC951
Description	4.5 V to 20 V input 25 A microBRICK® DC/DC converter with PMBus
Input voltage min. (V)	4.5
Input voltage max. (V)	20
Output voltage min. (V)	0.3
Output voltage max. (V)	5.5
Continuous current (A)	25
Switch frequency min. (kHz)	300
Switch frequency max. (kHz)	1500
Pre-bias operation (yes / no)	Yes
Internal bias reg. (yes / no)	Yes
Compensation	Internal
Enable (yes / no)	Yes
P _{GOOD} (yes / no)	Yes
Over current protection	Yes
Protection	OVP, OCP, UVP/SCP, OTP, UVLO
Light load mode	Power save
Peak efficiency (%)	96.6
Package type	PowerPAK MLP59-A6C
Package size (W, L, H) (mm)	10.6 x 6.5 x 3
Status code	1
Product type	microBRICK® (step down regulator)
Applications	n/a

Vishay Siliconix maintains worldwide manufacturing capability. Products may be manufactured at one of several qualified locations. Reliability data for Silicon Technology and Package Reliability represent a composite of all qualified locations. For related documents such as package / tape drawings, part marking, and reliability data, see www.vishay.com/ppg?71554.

PowerPAK® MLP60-A6C Case Outline

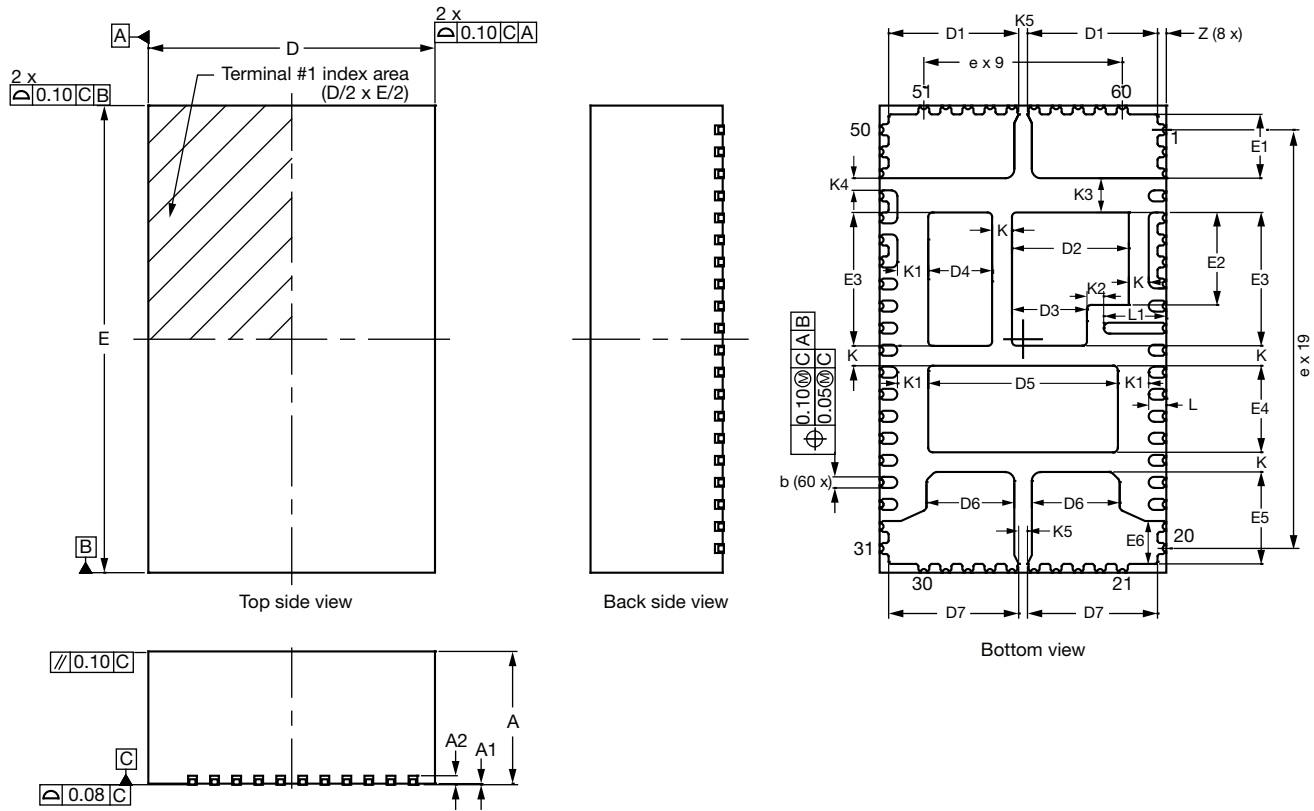

DIM.	MILLIMETERS			INCHES		
	MIN.	NOM.	MAX.	MIN.	NOM.	MAX.
A ⁽⁸⁾	2.95	3.00	3.05	0.116	0.118	0.120
A1	0.00	-	0.05	0.000	-	0.002
A2	0.20 ref.			0.008 ref.		
b ⁽⁴⁾	0.20	0.25	0.30	0.008	0.010	0.012
D	6.40	6.50	6.60	0.252	0.256	0.260
D1	2.85	2.95	3.05	0.112	0.116	0.120
D2	2.55	2.65	2.75	0.100	0.104	0.108
D3	1.60	1.70	1.80	0.063	0.067	0.071
D4	1.35	1.45	1.55	0.053	0.057	0.061
D5	4.20	4.30	4.40	0.165	0.169	0.173
D6	1.89	1.99	2.09	0.074	0.078	0.082
D7	2.85	2.95	3.05	0.112	0.116	0.120
E	10.50	10.60	10.70	0.413	0.417	0.421
E1	1.35	1.45	1.55	0.053	0.057	0.061
E2	2.00	2.10	2.20	0.079	0.083	0.087
E3	2.93	3.03	3.13	0.115	0.119	0.123
E4	1.86	1.96	2.06	0.073	0.077	0.081
E5	1.99	2.09	2.19	0.078	0.082	0.086
E6	0.88	0.98	1.08	0.035	0.039	0.043



DIM.	MILLIMETERS			INCHES		
	MIN.	NOM.	MAX.	MIN.	NOM.	MAX.
K	0.45 ref.			0.018 ref.		
K1	0.70 ref.			0.028 ref.		
K2	0.38 ref.			0.015 ref.		
K3	0.78 ref.			0.031 ref.		
K4	0.28 ref.			0.011 ref.		
K5	0.20 ref.			0.008 ref.		
L	0.30	0.40	0.50	0.012	0.016	0.020
L1	1.32	1.42	1.52	0.052	0.056	0.060
e	0.50 BSC			0.020 BSC		
Z	0.20 ref.			0.008 ref.		
ECN: T19-0039-Rev. B, 04-Mar-2019 DWG: 6072						

Notes

- (1) Use millimeters as the primary measurement
- (2) Dimensioning and tolerances conform to ASME Y14.5M. - 1994
- (3) N is the number of terminals, Nd is the number of terminals in x-direction, Ne is the number of terminals in y-direction
- (4) Dimension b applies to plated terminal and is measured between 0.20 mm and 0.25 mm from terminal tip
- (5) The pin #1 identifier must be existed on the top surface of the package by using indentation mark or other feature of package body
- (6) Exact shape and size of this feature is optional
- (7) Package warpage max. 0.08 mm
- (8) Applied only for terminals



Disclaimer

ALL PRODUCT, PRODUCT SPECIFICATIONS AND DATA ARE SUBJECT TO CHANGE WITHOUT NOTICE TO IMPROVE RELIABILITY, FUNCTION OR DESIGN OR OTHERWISE.

Vishay Intertechnology, Inc., its affiliates, agents, and employees, and all persons acting on its or their behalf (collectively, "Vishay"), disclaim any and all liability for any errors, inaccuracies or incompleteness contained in any datasheet or in any other disclosure relating to any product.

Vishay makes no warranty, representation or guarantee regarding the suitability of the products for any particular purpose or the continuing production of any product. To the maximum extent permitted by applicable law, Vishay disclaims (i) any and all liability arising out of the application or use of any product, (ii) any and all liability, including without limitation special, consequential or incidental damages, and (iii) any and all implied warranties, including warranties of fitness for particular purpose, non-infringement and merchantability.

Statements regarding the suitability of products for certain types of applications are based on Vishay's knowledge of typical requirements that are often placed on Vishay products in generic applications. Such statements are not binding statements about the suitability of products for a particular application. It is the customer's responsibility to validate that a particular product with the properties described in the product specification is suitable for use in a particular application. Parameters provided in datasheets and / or specifications may vary in different applications and performance may vary over time. All operating parameters, including typical parameters, must be validated for each customer application by the customer's technical experts. Product specifications do not expand or otherwise modify Vishay's terms and conditions of purchase, including but not limited to the warranty expressed therein.

Hyperlinks included in this datasheet may direct users to third-party websites. These links are provided as a convenience and for informational purposes only. Inclusion of these hyperlinks does not constitute an endorsement or an approval by Vishay of any of the products, services or opinions of the corporation, organization or individual associated with the third-party website. Vishay disclaims any and all liability and bears no responsibility for the accuracy, legality or content of the third-party website or for that of subsequent links.

Except as expressly indicated in writing, Vishay products are not designed for use in medical, life-saving, or life-sustaining applications or for any other application in which the failure of the Vishay product could result in personal injury or death. Customers using or selling Vishay products not expressly indicated for use in such applications do so at their own risk. Please contact authorized Vishay personnel to obtain written terms and conditions regarding products designed for such applications.

No license, express or implied, by estoppel or otherwise, to any intellectual property rights is granted by this document or by any conduct of Vishay. Product names and markings noted herein may be trademarks of their respective owners.