

**SERIES:** PQC75-0 | **DESCRIPTION:** DC-DC CONVERTER

**FEATURES**

- 75 W isolated output
- industry standard DOSA 1/16 brick
- 2:1 input range (36 ~75 Vdc)
- -40 ~ 85°C operating temperature
- over-current, input under-voltage, over-voltage and output short-circuit protection
- remote on/off control
- EN/BS EN/UL 62368 certified

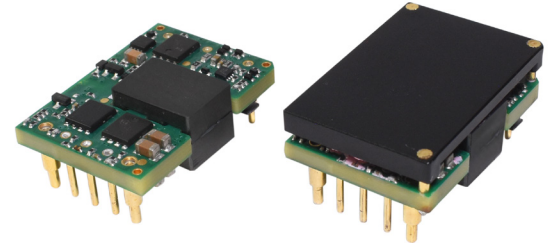

MODEL	input voltage		output voltage (Vdc)	output current		output power max (W)	ripple and noise <sup>1</sup> max (mVp-p)	efficiency <sup>2</sup> typ (%)
	typ (Vdc)	range (Vdc)		min (mA)	max (mA)			
PQC75-48-S5-O	48	36~75	5	0	15,000	75	150	92
PQC75-48-S12-O	48	36~75	12	0	6,250	75	150	92
PQC75-48-S28-O	48	36~75	28	0	2,678	75	150	90

- Notes:
1. Ripple and noise are measured at 20 MHz BW, 5%~100% load by "tip & barrel" method. Ripple & Noise at <5% load is 5%Vo max. Ripple & Noise at 28V output is 2%Vo max.
  2. Efficiency is measured at nominal input voltage and rated output load.
  3. All specifications are measured at Ta=25°C, humidity<75%, nominal input voltage and rated output load unless otherwise specified.

**PART NUMBER KEY**

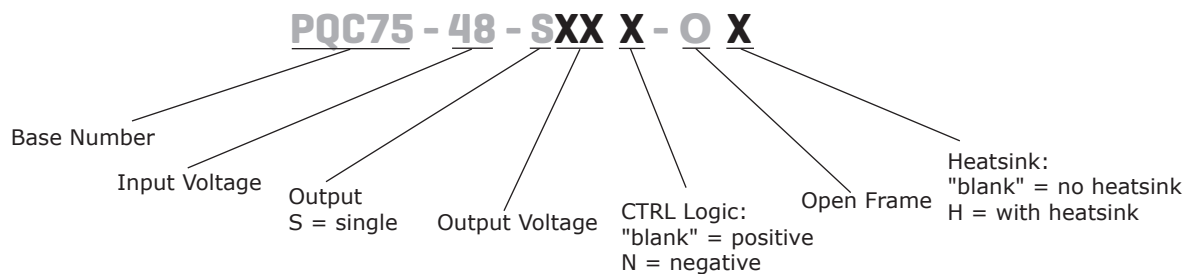

## INPUT

parameter	conditions/description	min	typ	max	units
operating input voltage		36	48	80	Vdc
current (full load/no load)	at nominal input voltage		1,669/10	1,776/30	mA
reflected ripple current	at nominal input voltage		30		mA
start-up voltage				36	Vdc
under-voltage protection		26	29		Vdc
start-up time	at nominal input voltage & constant resistance load			100	ms
surge voltage	for maximum of 1 second	-0.7		80	Vdc
CTRL <sup>3</sup>	positive logic	module ON: CTRL pin open or pulled high (4.5~12Vdc)			
		module OFF: CTRL pin pulled low to GND (0~1.2Vdc)			
	negative logic	module ON: CTRL pin pulled low to GND (0~1.2Vdc)			
		module OFF: CTRL pin open or pulled high (4.5~12Vdc)			
standby current	CTRL pin pulled low		3	10	mA
filter	Pi filter				

Notes: 3. The CTRL pin voltage is referenced to input GND.

## OUTPUT

parameter	conditions/description	min	typ	max	units
maximum capacitive load <sup>4</sup>	5 Vdc output			6,000	μF
	12 Vdc output			2,000	μF
	28 Vdc output			1,000	μF
line regulation <sup>5</sup>	full load, input voltage from low to high		±0.2	±0.5	%
load regulation	5% to 100% load		±0.5	±0.75	%
voltage accuracy	5% to 100% load		±1	±3	%
switching frequency <sup>6</sup>	PWM mode		300		kHz
transient recovery time	25% load step change, nominal input		200	500	μs
transient response deviation	25% load step change, nominal input		±3	±8	%
	5 Vdc output voltage all other outputs		±3	±7	%
temperature coefficient	full load			±0.03	%/°C
trim		90		110	%
remote sense compensation				105	%

Notes: 4. The maximum capacitive load offered were tested at input voltage range and full load.

5. Line regulation for 0%~100% load is ±3%.

6. Switching frequency is measured at full load. The module reduces the switching frequency for light load (below 50%) efficiency improvement.

## PROTECTIONS

parameter	conditions/description	min	typ	max	units
over voltage protection		110	125	160	%
over current protection		110	140	190	%
short circuit protection	auto recovery, continuous				

## SAFETY AND COMPLIANCE

parameter	conditions/description	min	typ	max	units
isolation voltage	input to output for 1 minute at 1 mA max.	1,500			Vdc
isolation resistance	input to output at 500 Vdc	1,000			MΩ
isolation capacitance	input to output at 100kHz/0.1V		1,000		pF
vibration	10-150Hz, 10G, 30min. along X, Y and Z				

**SAFETY AND COMPLIANCE (CONTINUED)**

parameter	conditions/description	min	typ	max	units
safety approvals	certified 62368: EN, BS EN, UL				
conducted emissions	CISPR32/EN55032 CLASS A (see Fig.2 for recommended circuit) CISPR32/EN55032 CLASS B (see Fig.3 & 4 for recommended circuit)				
radiated emissions	CISPR32/EN55032 CLASS A (see Fig.2 for recommended circuit) CISPR32/EN55032 CLASS B (see Fig.3 & 4 for recommended circuit)				
ESD	IEC/EN61000-4-2 Contact $\pm 6\text{kV}$ /Air $\pm 8\text{kV}$ , perf. Criteria B				
radiated immunity	IEC/EN61000-4-3 10V/m, perf. Criteria B				
EFT/burst	IIEC/EN61000-4-4 100kHz $\pm 2\text{kV}$ (see Fig. 2 for recommended circuit), perf. Criteria B				
surge	IEC/EN61000-4-5 line to line $\pm 2\text{kV}$ (see Fig. 2 for recommended circuit), perf. Criteria B				
conducted immunity	IEC/EN61000-4-6 3 Vrms, perf. Criteria B				
MTBF	as per MIL-HDBK-217F at 25°C	500,000			hours
RoHS	yes				

**ENVIRONMENTAL**

parameter	conditions/description	min	typ	max	units
operating temperature	see derating curve	-40		85	°C
storage temperature		-55		125	°C
storage humidity	non-condensing	5		95	%

**MECHANICAL**

parameter	conditions/description	min	typ	max	units
dimensions	5 & 12 Vdc output model no heatsink	33.02 x 22.86 x 9.75 [1.300 x 0.900 x 0.384 inch]			mm
	5 & 12 Vdc output model with heatsink	33.02 x 22.86 x 12.7 [1.300 x 0.900 x 0.500 inch]			mm
	28 Vdc output model no heatsink	33.02 x 22.86 x 10.05 [1.300 x 0.900 x 0.396 inch]			mm
	28 Vdc output model with heatsink	33.02 x 22.86 x 13.0 [1.300 x 0.900 x 0.512 inch]			mm
weight	without heatsink		14.6		g
	with heatsink		21.4		g
cooling method	natural convection or forced air				

## MECHANICAL DRAWING

### 5 VDC & 12 VDC OUTPUT MODEL WITHOUT HEATISINK

units: mm[inch]  
 tolerance:  $\pm 0.50[\pm 0.020]$   
 pin section tolerance:  $\pm 0.10[\pm 0.004]$   
 pin 1,2,3,5,6,7:  $\varnothing 1.0\text{mm}$   
 pin 4,8:  $\varnothing 1.5\text{mm}$

Note: The layout of the device is for reference only, please refer to the actual product.

PIN CONNECTIONS	
PIN	Function
1	+Vin
2	CTRL
3	-Vin
4	0V
5	Sense-
6	Trim
7	Sense+
8	+Vo

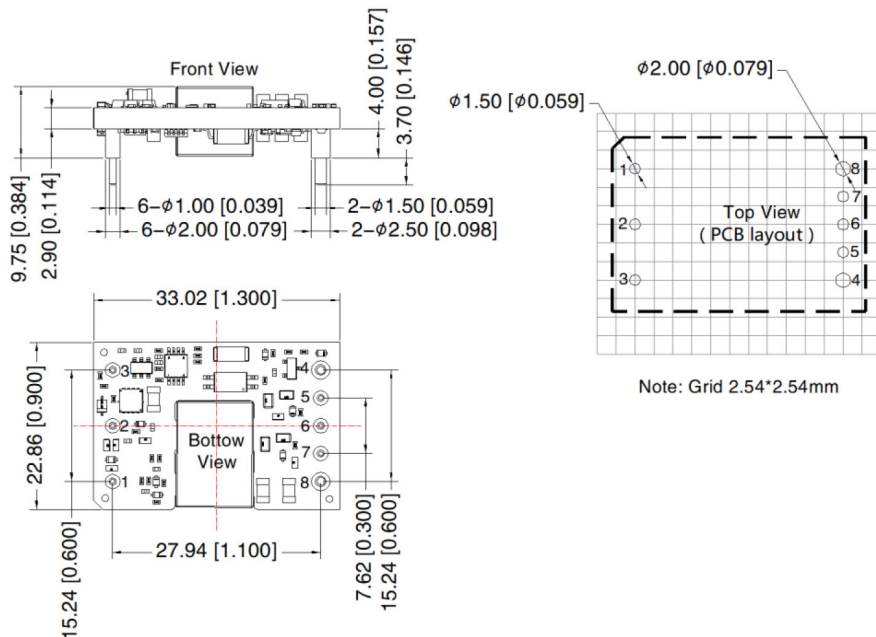

### 28 VDC OUTPUT MODEL WITHOUT HEATISINK

units: mm[inch]  
 tolerance:  $\pm 0.50[\pm 0.020]$   
 pin section tolerance:  $\pm 0.10[\pm 0.004]$   
 pin 1,2,3,5,6,7:  $\varnothing 1.0\text{mm}$   
 pin 4,8:  $\varnothing 1.5\text{mm}$

Note: The layout of the device is for reference only, please refer to the actual product.

PIN CONNECTIONS	
PIN	Function
1	+Vin
2	CTRL
3	-Vin
4	0V
5	Sense-
6	Trim
7	Sense+
8	+Vo

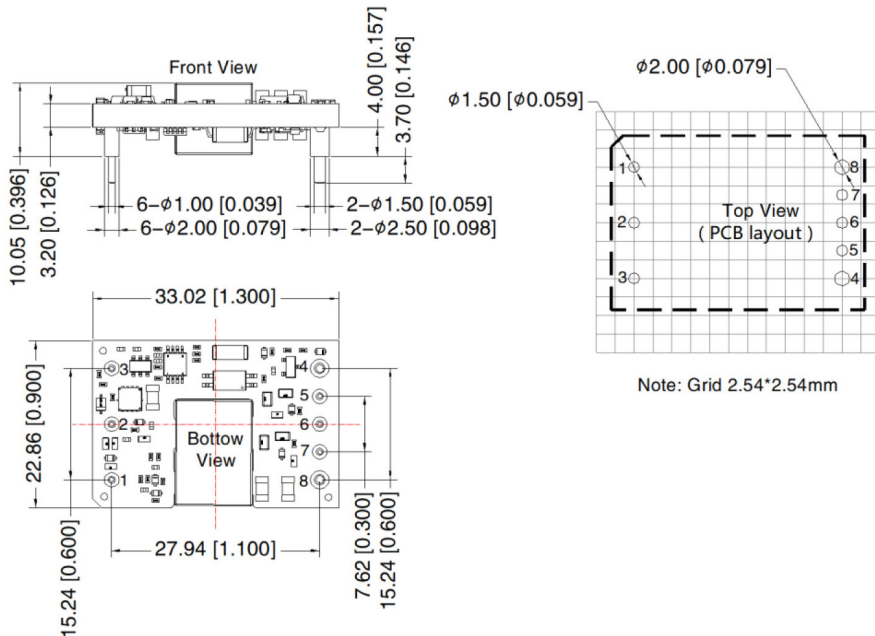

## MECHANICAL DRAWING (CONTINUED)

### 5 VDC & 12 VDC OUTPUT MODEL WITH HEATISINK

units: mm[inch]  
 tolerance:  $\pm 0.50[\pm 0.020]$   
 pin section tolerance:  $\pm 0.10[\pm 0.004]$   
 pin 1,2,3,5,6,7:  $\varnothing 1.0\text{mm}$   
 pin 4,8:  $\varnothing 1.5\text{mm}$

Note: The layout of the device is for reference only, please refer to the actual product.

PIN CONNECTIONS	
PIN	Function
1	+Vin
2	CTRL
3	-Vin
4	0V
5	Sense-
6	Trim
7	Sense+
8	+Vo

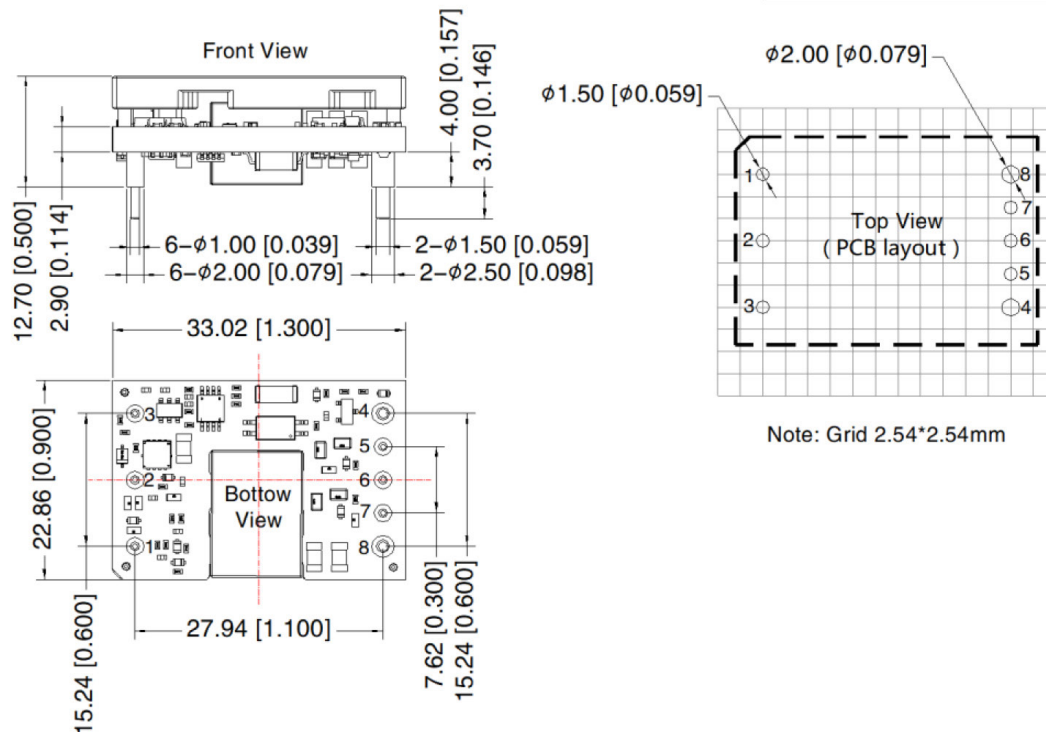

### 28 VDC OUTPUT MODEL WITH HEATISINK

units: mm[inch]  
 tolerance:  $\pm 0.50[\pm 0.020]$   
 pin section tolerance:  $\pm 0.10[\pm 0.004]$   
 pin 1,2,3,5,6,7:  $\varnothing 1.0\text{mm}$   
 pin 4,8:  $\varnothing 1.5\text{mm}$

Note: The layout of the device is for reference only, please refer to the actual product.

PIN CONNECTIONS	
PIN	Function
1	+Vin
2	CTRL
3	-Vin
4	0V
5	Sense-
6	Trim
7	Sense+
8	+Vo

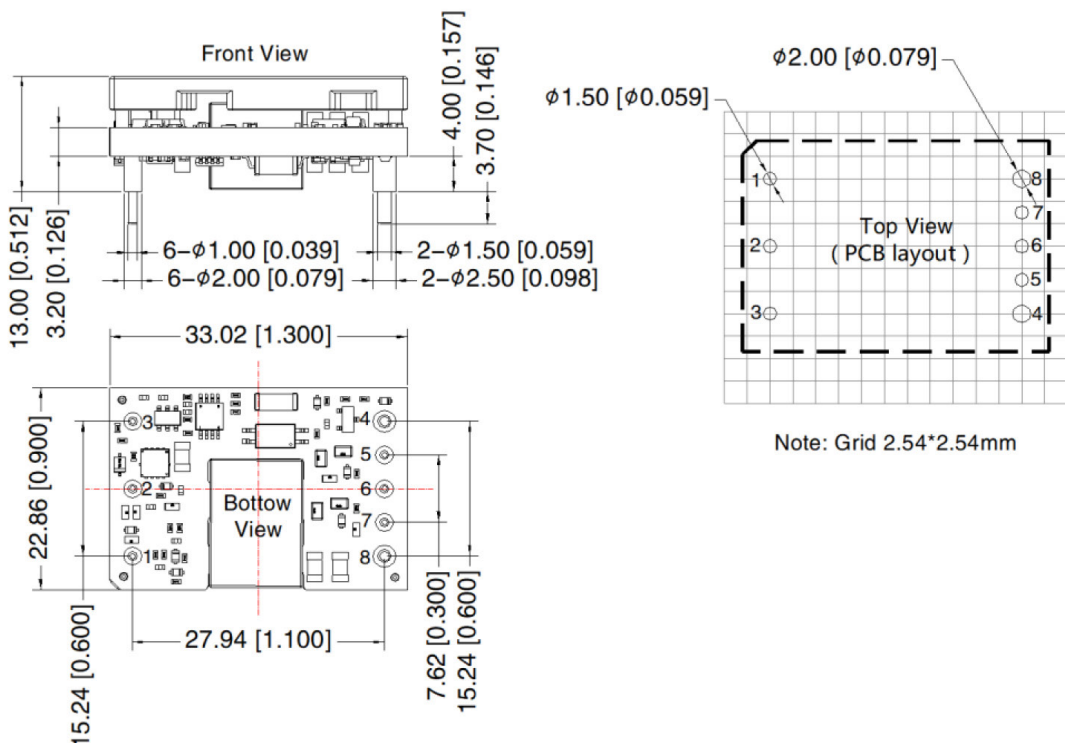

## DERATING CURVE

**TEMPERATURE DERATING CURVE  
(without heatsink)**

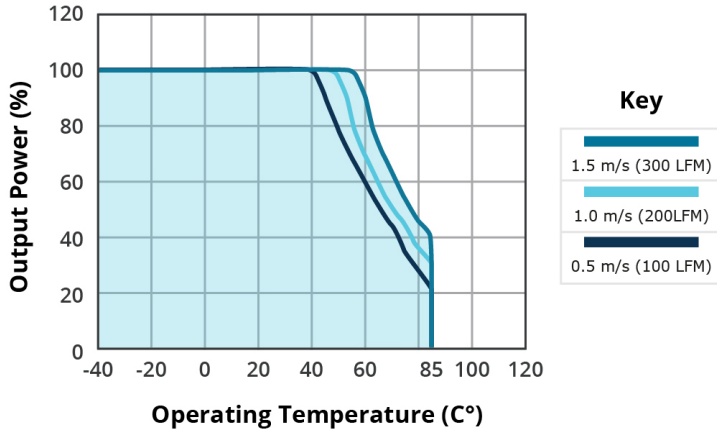

**TEMPERATURE DERATING CURVE  
(with heatsink)**

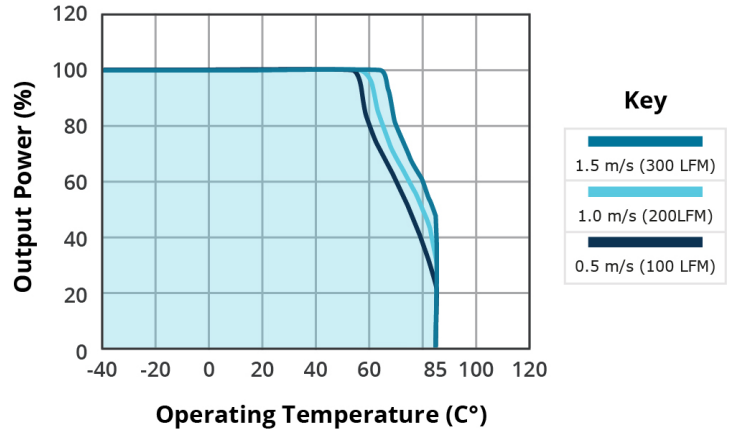

## EFFICIENCY CURVES

**EFFICIENCY VS INPUT VOLTAGE  
(full load)**

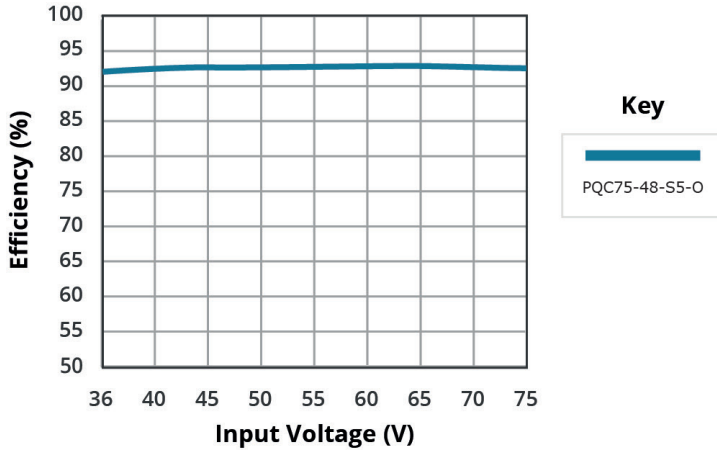

**EFFICIENCY VS OUTPUT LOAD  
(Vin = 48V)**

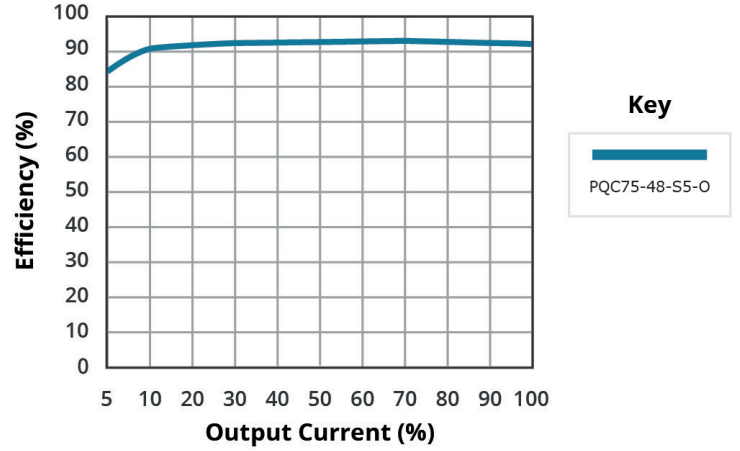

## APPLICATION NOTES

Please ensure that at least a 100µF electrolytic capacitors is connected at the input in order to ensure adequate voltage surge suppression and protection. Input and/or output ripple can be further reduced by appropriately increasing the input & output capacitor values  $C_{in}$  and  $C_{out}$  and/or by selecting capacitors with a low ESR (equivalent series resistance). Also make sure that the capacitance is not exceeding the specified max. capacitive load value of the product.

Figure 1

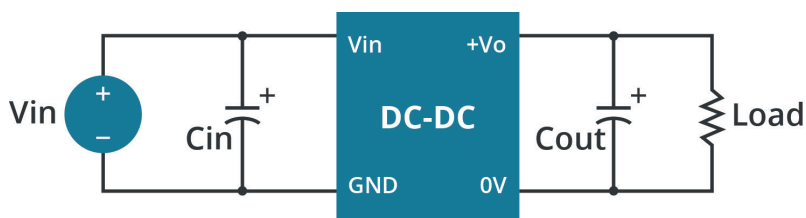
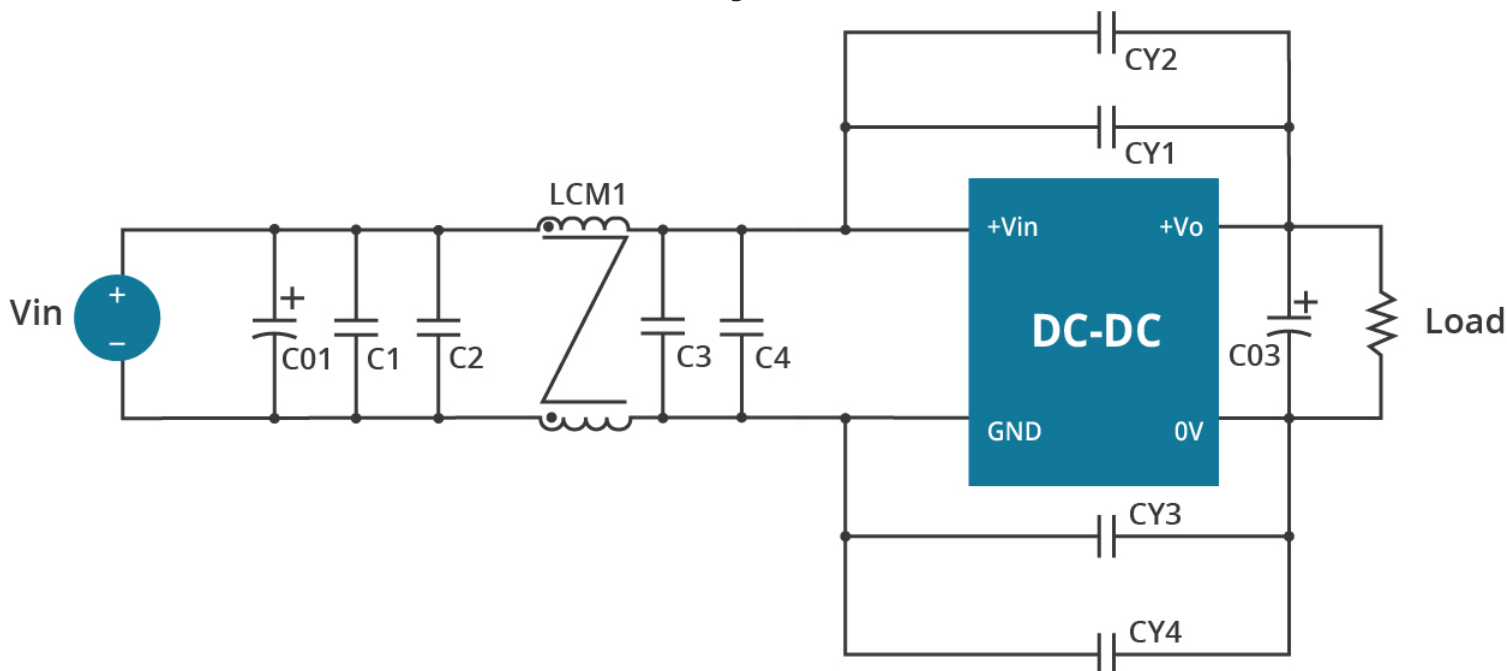

Table 1

Vout (Vdc)	Cin (µF/V)	Cout (µF/V)
5	100µF/100V	330µF/63V
12		
28		

## EMC CLASS A RECOMMENDED CIRCUIT

Figure 2



Notes: For EMC tests we use Part 2 in Fig. 2 for immunity and part 1 for emissions test. Selecting based on needs.

Table 2

Recommended external circuit components	
C01	2000µF/100V electrolytic capacitor
C03	330µF/100V electrolytic capacitor
C1, C2, C3, C4	4.7µF/100V
CY1, CY2, CY3, CY4	222M/400V
LCM1	2.0mH

## EMC CLASS B RECOMMENDED CIRCUITS

**Figure 3**  
5 VDC & 12 VDC OUTPUT MODELS

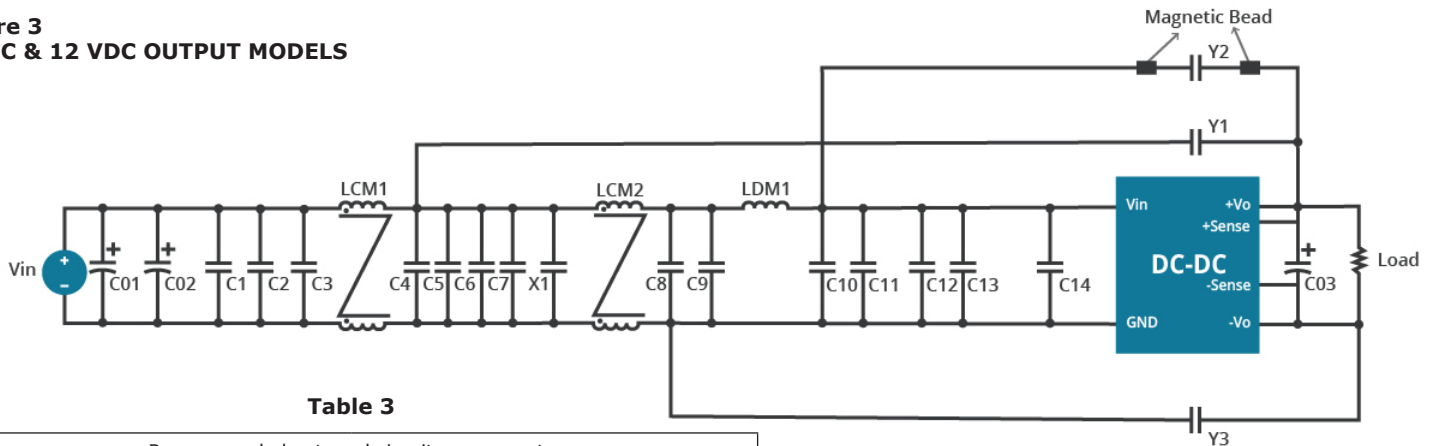

**Table 3**

Recommended external circuit components	
C01, C02	1000 $\mu$ F/100V electrolytic capacitor
C03	330 $\mu$ F/100V electrolytic capacitor
C1, C2, C3, C4, C5, C6, C7, C8, C9, C10, C11, C12, C13, C14	4.7 $\mu$ F/100V
X1	0.22 $\mu$ F/250V
Y1, Y3	102M/400V
Y2	222M/400V
LCM1	60 $\mu$ H/TL15
LCM2	2.0 $\mu$ H
LDM1	12 $\mu$ H
MB	B40/T3.5*1.5*2.35HP (ACME)

**Figure 4**  
28 VDC OUTPUT MODEL

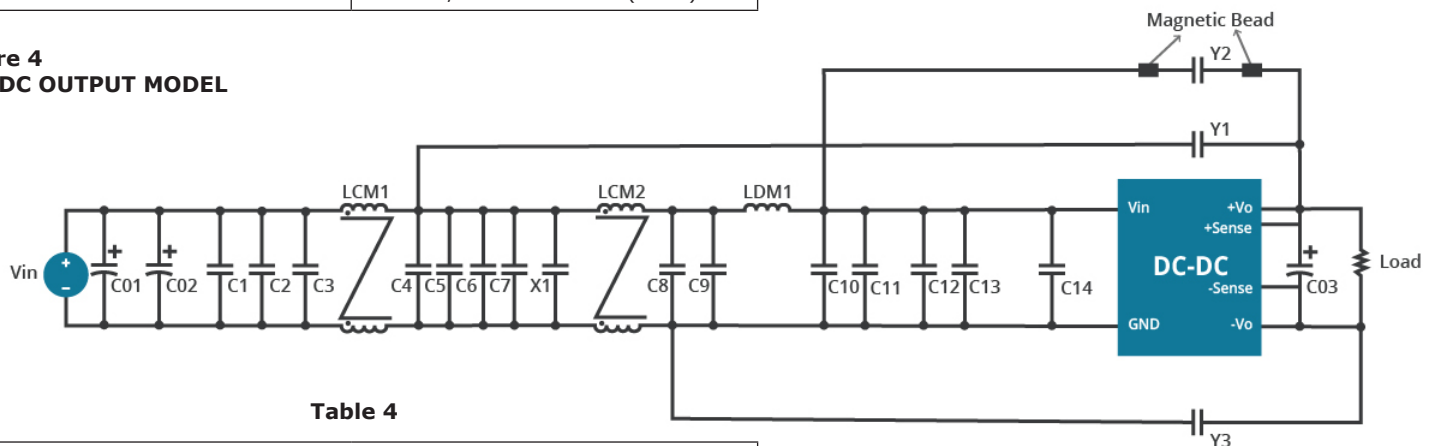

**Table 4**

Recommended external circuit components	
C01, C02	1000 $\mu$ F/100V electrolytic capacitor
C03	330 $\mu$ F/100V electrolytic capacitor
C1, C2, C3, C4, C5, C6, C7, C8, C9, C10, C11, C12, C13, C14	4.7 $\mu$ F/100V
X1	0.22 $\mu$ F/250V
Y1	102M/400V
Y2	222M/400V
LCM1	60 $\mu$ H/TL15
LCM2	2.0 $\mu$ H
LDM1	12 $\mu$ H
MB	B40/T3.5*1.5*2.35HP (ACME)



## RIPPLE AND NOISE

All the DC-DC converters of this series are tested before delivery using the recommended circuit shown in Fig. 5

Figure 5

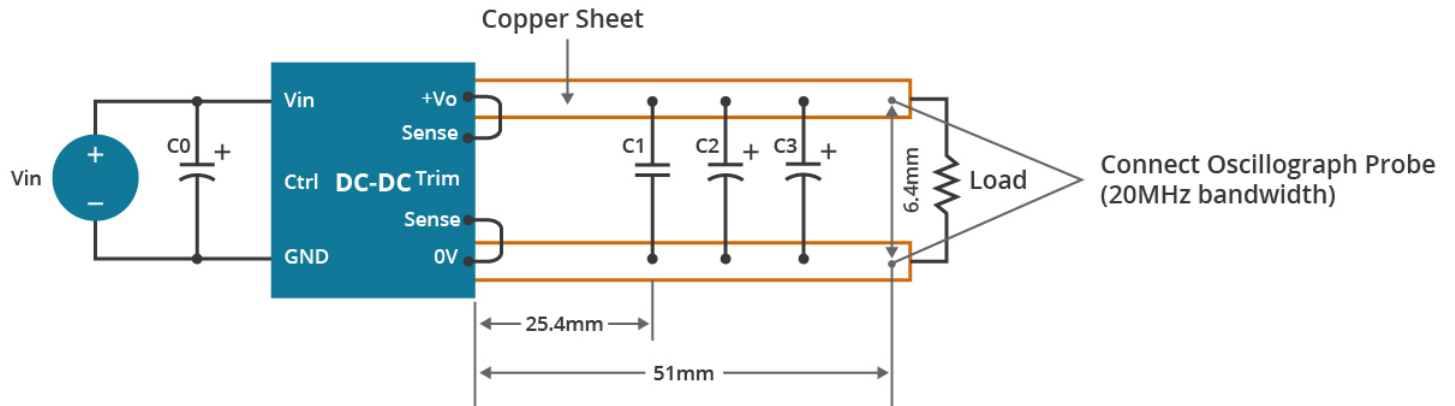
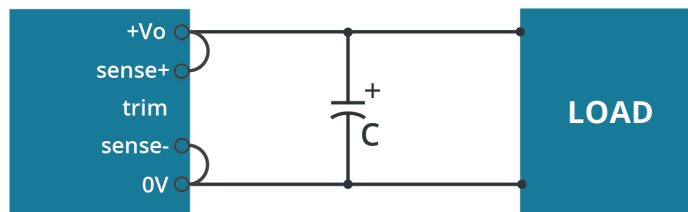

Table 5

Vout (Vdc)	C0 (μF/V)	C1 (μF/V)	C2 (μF/V)	C3 (μF/V)
5	100μF/100V	1μF/50V	10μF/50V	330μF/63V
12				
28				

## REMOTE SENSE APPLICATION

**Figure 6**  
**REMOTE SENSE CONNECTION**  
**IF NOT USED**



- Note:
1. Lines must be kept as short as possible.
  2. If the sense function is not used for remote regulation the user must connect the +Sense to + Vo and -Sense to 0V at the DC-DC converter pins and will compensate for voltage drop across pins only.
  3. The connections between Sense lines and their respective power lines must be kept as short as possible, otherwise they may be picking up noise, interference and/or causing unstable operation of the power module.

**Figure 7**  
**REMOTE SENSE CONNECTION**  
**USED FOR COMPENSATION**

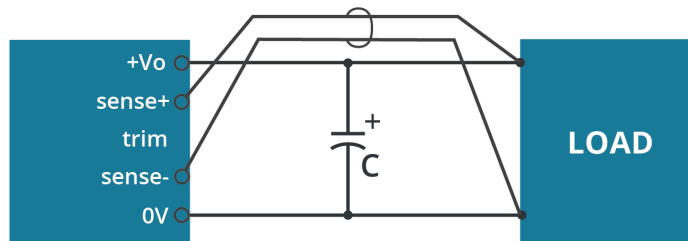

- Note:
1. In cables and discrete wiring applications, twisted pair or other techniques should be implemented.
  2. Using remote sense with long wires may cause unstable output, please contact technical support if long wires must be used.
  3. PCB-tracks or cables/wires for Remote Sense must be kept as short as possible. Twisted pair or shielded wires are suggested for remote compensation and must be kept as short as possible.
  4. We recommend using adequate cross section for PCB-track layout and/or cables to connect the power supply module to the load in order to keep the voltage drop below 0.3V and to make sure the power supply's output voltage remains within the specified range.
  5. Note that large wire impedance may cause oscillation of the output voltage and/or increased ripple. Consult technical support or factory for further advice of sense operation.

## APPLICATION NOTES

Figure 8

Trim up

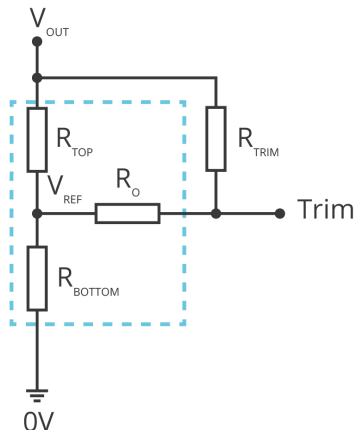

Trim down

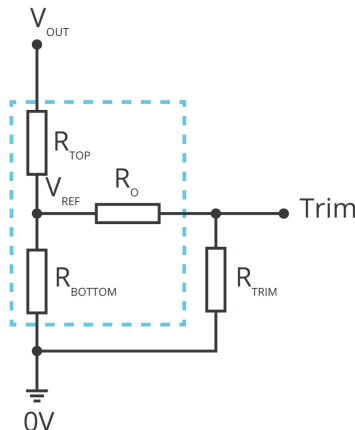

$$R_{TRIM} = \left( \frac{5.11 \cdot V_{NOM} (100 + \Delta\%)}{1.225 \Delta\%} - \frac{511}{\Delta\%} - 10.22 \right) (K\Omega)$$

Formula for Trim up

$$R_{TRIM} = \left( \frac{511}{\Delta\%} \right) - 10.22 (K\Omega)$$

Formula for Trim down

Note:  $R_{TRIM}$ : Trim resistance

$$\Delta\%: \Delta\% = \left| \frac{V_{NOM} - V_{OUT}}{V_{NOM}} \right| \times 100$$

$V_{NOM}$ : Nominal output voltage

$V_{OUT}$ : Target output voltage

## THERMAL TEST POINT

The thermal element is installed on the top surface of the product and dissipates heat to the surrounding environment through conduction, convection and radiation. Sufficient heat dissipation conditions should be provided to ensure the reliable operation of the product. By measuring the temperature of the thermal test point in Fig. 9, it can be verified whether the heat dissipation conditions are met.

Figure 9

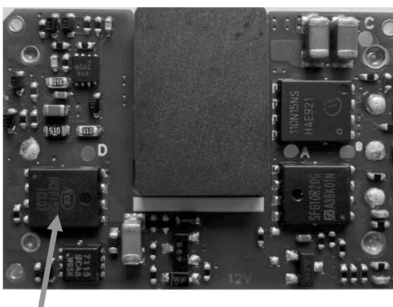

- Note:
1. The temperature of the negative logic series Thermal Test Point 1 cannot exceed 130°C. Otherwise, the product will trigger the protection due to excessive temperature and can not work properly.
  2. Positive logic series without over-temperature protection function, the temperature of Thermal Test Point 1 cannot exceed 130°C. Otherwise, the product will be damaged due to excessive temperature.

## REVISION HISTORY

---

rev.	description	date
1.0	initial release	07/21/2023

The revision history provided is for informational purposes only and is believed to be accurate.



**CUI INC**  
a bel group

**Headquarters**  
20050 SW 112th Ave.  
Tualatin, OR 97062  
**800.275.4899**

Fax 503.612.2383  
**cui.com**  
techsupport@cui.com

CUI offers a two (2) year limited warranty. Complete warranty information is listed on our website.

CUI reserves the right to make changes to the product at any time without notice. Information provided by CUI is believed to be accurate and reliable. However, no responsibility is assumed by CUI for its use, nor for any infringements of patents or other rights of third parties which may result from its use.

CUI products are not authorized or warranted for use as critical components in equipment that requires an extremely high level of reliability. A critical component is any component of a life support device or system whose failure to perform can be reasonably expected to cause the failure of the life support device or system, or to affect its safety or effectiveness.