

## Low Building Height Metallized Polypropylene DC-Link Film Capacitor - THB and Automotive Grade



### FEATURES

- AEC-Q200 qualified (rev. D) up to 105 °C
- High robustness under high humidity
- THB 60 °C, 93 %, 56 days RH at rated  $U_{NDC}$
- High ripple current capability, low ESR, low ESL
- Mounting: radial
- Material categorization: for definitions of compliance please see [www.vishay.com/doc?99912](http://www.vishay.com/doc?99912)

 AUTOMOTIVE  
GRADE

**RoHS**  
COMPLIANT

### APPLICATIONS

- EV/PHEV power converters
- On-board and inductive charging systems
- Automotive HVAC systems
- Motor drives

QUICK REFERENCE DATA	
Rated capacitance range	1 µF to 75 µF
Capacitance tolerance	5 %, 10 %
Rated voltage range, $U_{NDC}$	500 V to 1200 V
Climatic testing class	40/105/56
Rated temperature	85 °C
Maximum operation temperature	105 °C, observing voltage derating
Maximum applicable peak to peak ripple voltage	0.2 x $U_{NDC}$
Reference standards	AEC-Q200 rev. D, IEC 61071
Dielectric	Polypropylene film
Electrodes	Metallized dielectric capacitor
Construction	Mono construction
Encapsulation	Plastic case sealed with resin; flame retardant
Terminals	Tinned wire
Self inductance ( $L_S$ )	< 0.6 nH per mm of lead spacing
Withstanding DC voltage between terminals <sup>(1)</sup>	1.5 $U_{NDC}$ for 10 s, cut-off current 10 mA, rise time ≤ 1000 V/s
Insulation resistance	RC between leads, after 60 s > 10 000 s For $U_{NDC} \leq 500$ V measuring voltage 100 V For $U_{NDC} > 500$ V measuring voltage 500 V
Life time expectancy	Useful life time: > 100 000 h at $U_{NDC}$ and 70 °C FIT: < 10 x 10 <sup>-9</sup> /h (10 per 10 <sup>9</sup> component h) at 0.5 $U_{NDC}$ , 40 °C
Marking	Manufacturer's name; C-value; tolerance; rated voltage; manufacturer's type designation; code for dielectric material; manufacturer's location; year (yy) and week (ww) of manufacture

#### Notes

- For more detailed data and test requirements, contact [dc-film@vishay.com](mailto:dc-film@vishay.com)
- For general information like characteristics and definitions used for film capacitors follow the link: [www.vishay.com/doc?28147](http://www.vishay.com/doc?28147)
- <sup>(1)</sup> See document "Voltage Proof Test for Metallized Capacitors" ([www.vishay.com/doc?28169](http://www.vishay.com/doc?28169))

DC VOLTAGE RATINGS				
$U_{NDC}$ at 85 °C	500 V	700 V	900 V	1200 V
$U_{OPDC}$ at 70 °C	600 V	800 V	1100 V	1500 V
$U_{OPDC}$ at 105 °C	350 V	500 V	650 V	850 V



## COMPOSITION OF CATALOG NUMBER

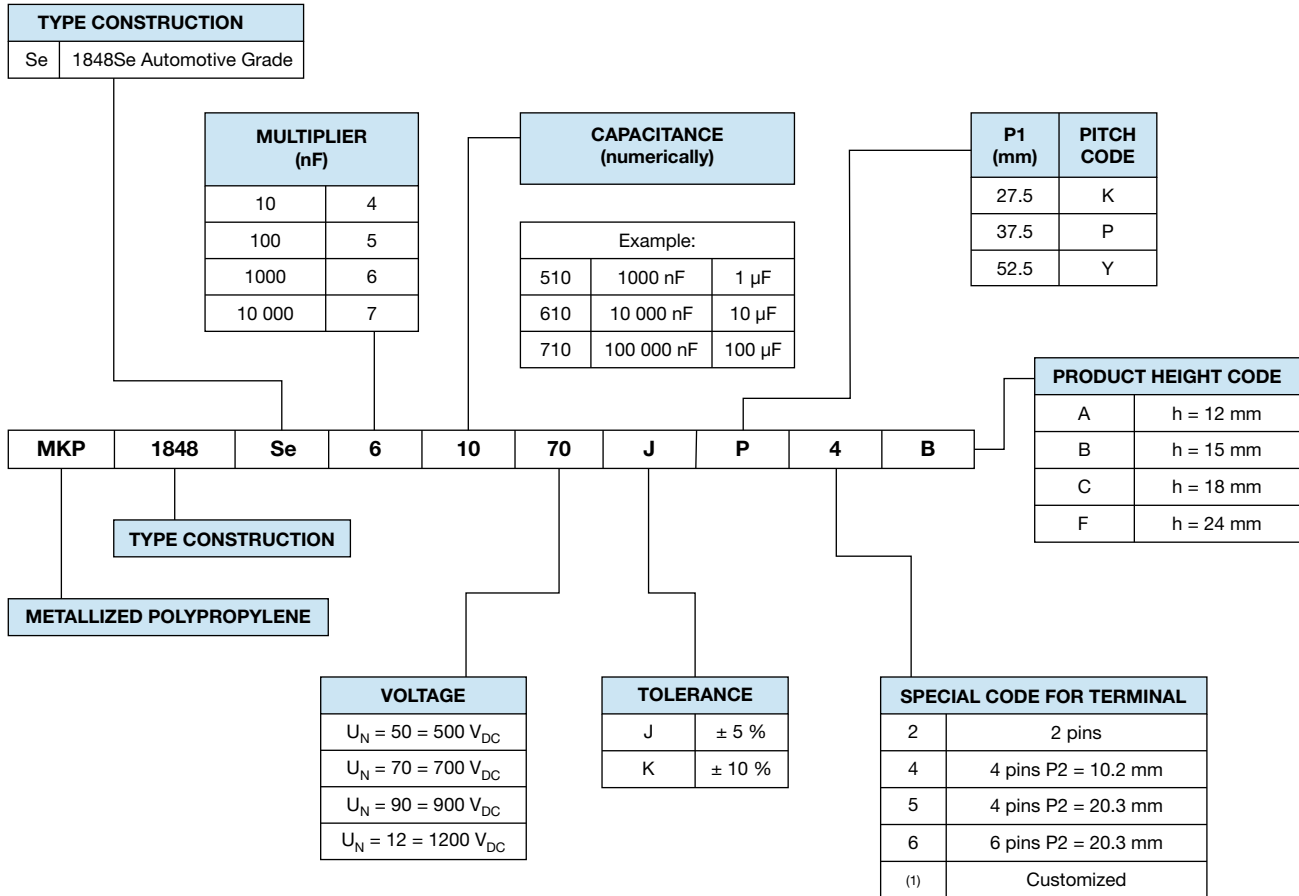

### Note

(1) Tabs terminals or customized terminals are available on request

DIMENSIONS in millimeters	
<p> <math>P1 \pm 0.5 \text{ mm}</math>  <math>l_t = 6 \text{ mm} + 0 \text{ mm} / - 1 \text{ mm}</math> </p>	
<p> <math>P1 \text{ and } P2 \pm 0.5 \text{ mm}</math>  <math>l_t = 6 \text{ mm} + 0 \text{ mm} / - 2 \text{ mm}</math> </p>	
<p> <math>P1 \text{ and } P2 \pm 0.5 \text{ mm}</math>  <math>l_t = 6 \text{ mm} + 0 \text{ mm} / - 2 \text{ mm}</math> </p>	

**Note**

- $\varnothing dt \pm 10 \%$  of standard diameter specified



ELECTRICAL DATA AND ORDERING CODE																
U <sub>NDC</sub> (V)	HEIGHT (mm)	CAP. <sup>(1)</sup> (µF)	DIMENSION <sup>(2)</sup> (mm)			P1 (mm)	P2 (mm)	dU/dt (V/µs)	I <sub>PEAK</sub> (A)	I <sub>RMS</sub> <sup>(3)</sup> (A)		ESR <sup>(4)</sup> (mΩ)		tan δ ( $< 10^{-4}$ ) <sup>(5)</sup>		ORDERING CODE <sup>(6)</sup>
			w	h	l					2 PINS	4 PINS	2 PINS	4 PINS	2 PINS	4 PINS	
500	12	4	24.0	12.0	31.5	27.5	-	33	132	6	-	15	-	50	-	MKP1848Se54050+K2A
		7	27.0	15.0	31.5	27.5	-	33	231	9	-	9	-	50	-	MKP1848Se57050+K2B
	15	10	27.0	15.0	42.0	37.5	10.2	17	170	8	8	12	12	100	100	MKP1848Se61050+P*B
		15	33.0	15.0	42.0	37.5	10.2	17	255	11	11	8	8	100	100	MKP1848Se61550+P*B
	18	10	24.0	18.0	42.0	37.5	10.2	17	170	8	8	12	12	100	100	MKP1848Se61050+P*C
		15	27.0	18.0	42.0	37.5	10.2	17	255	10	10	8	8	100	100	MKP1848Se61550+P*C
		20	39.0	18.0	42.0	37.5	10.2	17	340	13	14	6	6	100	100	MKP1848Se62050+P*C
	24	30	35.0	18.0	57.5	52.5	20.3	8	240	12	12	8	8	200	200	MKP1848Se63050+Y*C
		20	30.0	24.0	42.0	37.5	10.2	17	340	13	13	6	6	100	100	MKP1848Se62050+P*F
		30	39.0	24.0	42.0	37.5	10.2	17	510	17	18	4	4	100	100	MKP1848Se63050+P*F
		45	39.0	24.0	57.5	52.5	20.3	8	360	17	17	6	5	200	200	MKP1848Se64550+Y*F
		75 <sup>(7)</sup>	70.0	24.0	57.5	52.5	20.3	8	600	-	27	-	3	-	200	MKP1848Se67550+Y6F
700	12	2	24.0	12.0	31.5	27.5	-	43	86	5	-	22	-	40	-	MKP1848Se52070+K2A
		4	27.0	15.0	31.5	27.5	-	43	172	8	-	11	-	40	-	MKP1848Se54070+K2B
	15	6	27.0	15.0	42.0	37.5	10.2	21	126	7	7	15	15	70	70	MKP1848Se56070+P*B
		8	33.0	15.0	42.0	37.5	10.2	21	168	9	9	11	11	70	70	MKP1848Se58070+P*B
	18	7	24.0	18.0	42.0	37.5	10.2	21	147	8	8	13	12	70	70	MKP1848Se57070+P*C
		8	27.0	18.0	42.0	37.5	10.2	21	168	9	9	11	11	70	70	MKP1848Se58070+P*C
		12	39.0	18.0	42.0	37.5	10.2	21	252	12	12	7	7	70	70	MKP1848Se61270+P*C
	24	15	35.0	18.0	57.5	52.5	20.3	11	165	10	10	12	12	150	140	MKP1848Se61570+Y*C
		12	30.0	24.0	42.0	37.5	10.2	21	252	12	12	7	7	70	70	MKP1848Se61270+P*F
		18	39.0	24.0	42.0	37.5	10.2	21	378	16	16	5	5	70	70	MKP1848Se61870+P*F
		25	39.0	24.0	57.5	52.5	20.3	11	275	14	15	7	7	150	150	MKP1848Se62570+Y*F
		50 <sup>(7)</sup>	70.0	24.0	57.5	52.5	20.3	11	550	-	25	-	4	-	150	MKP1848Se65070+Y6F
900	12	2	24.0	12.0	31.5	27.5	-	41	82	5	-	20	-	30	-	MKP1848Se52090+K2A
		5	27.0	15.0	42.0	37.5	10.2	20	100	6	6	16	16	70	70	MKP1848Se55090+P*B
	15	7	33.0	15.0	42.0	37.5	10.2	20	140	8	8	11	11	70	70	MKP1848Se57090+P*B
		5	24.0	18.0	42.0	37.5	10.2	20	100	6	6	16	16	70	60	MKP1848Se55090+P*C
	18	7	27.0	18.0	42.0	37.5	10.2	20	140	8	8	11	11	70	70	MKP1848Se57090+P*C
		10	39.0	18.0	42.0	37.5	10.2	20	200	10	10	8	8	70	70	MKP1848Se61090+P*C
	24	10	30.0	24.0	42.0	37.5	10.2	20	200	10	10	8	8	70	70	MKP1848Se61090+P*F
		15	39.0	24.0	42.0	37.5	10.2	20	300	13	14	6	5	70	70	MKP1848Se61590+P*F
		20	39.0	24.0	57.5	52.5	20.3	10	200	12	12	8	8	130	130	MKP1848Se62090+Y*F
		35 <sup>(7)</sup>	70.0	24.0	57.5	52.5	20.3	10	350	-	19	-	5	-	130	MKP1848Se63590+Y6F
1200	12	1	24.0	12.0	31.5	27.5	-	55	55	4	-	29	-	20	-	MKP1848Se51012+K2A
		2	27.0	15.0	31.5	27.5	-	55	110	6	-	15	-	20	-	MKP1848Se52012+K2B
	18	3	24.0	18.0	42.0	37.5	10.2	27	81	6	6	20	20	50	50	MKP1848Se53012+P*C
		5	39.0	18.0	42.0	37.5	10.2	31	155	9	9	11	11	50	50	MKP1848Se55012+P*C
	24	7	35.0	18.0	57.5	52.5	20.3	13	91	7	7	17	17	100	100	MKP1848Se57012+Y*C
		7	39.0	24.0	42.0	37.5	10.2	31	217	11	11	8	8	50	50	MKP1848Se57012+P*F
	24	10	39.0	24.0	57.5	52.5	20.3	15	150	10	10	11	11	90	90	MKP1848Se61012+Y*F
		12	39.0	24.0	57.5	52.5	20.3	13	156	11	11	10	10	100	100	MKP1848Se61212+Y*F
		15	70.0	24.0	57.5	52.5	20.3	15	225	-	15	-	7	-	90	MKP1848Se61512+Y5F
		20	70.0	24.0	57.5	52.5	20.3	13	260	-	17	-	6	-	100	MKP1848Se62012+Y5F
	24 <sup>(7)</sup>	70.0	24.0	57.5	52.5	20.3	13	312	-	18	-	5	-	100	MKP1848Se62412+Y6F	

Notes

- (1) Intermediate capacitance values available on request
- (2) Standard dimension. For tolerances, refer to the "Space Requirements for Printed Circuit Boards and Dimension Tolerances" section
- (3) Maximum RMS current for ambient temperature of +85 °C. For other operating conditions, see "Power Dissipation and Maximum Component Temperature Rise" section
- (4) Equivalent Series Resistance typical values at 10 kHz
- (5) Maximum tan δ values at 10 kHz
- (6) Change the "" symbol with special code for the pins, and "+" for tolerance
- (7) Only available with 6 pins



PACKAGING INFORMATION						
U <sub>NDC</sub> (V)	HEIGHT (mm)	CAP. (µF)	Ø dt	ORDERING CODE	MASS (g)	SPQ <sup>(1)</sup> (pcs)
500	12	4	0.8	MKP1848Se 540 50 +K2A	12	99
		7	0.8	MKP1848Se 570 50 +K2B	16	90
	15	10	1.0	MKP1848Se 610 50 +P*B	21	70
		15	1.0	MKP1848Se 615 50 +P*B	25	56
		10	1.0	MKP1848Se 610 50 +P*C	22	77
	18	15	1.0	MKP1848Se 615 50 +P*C	23	70
		20	1.0	MKP1848Se 620 50 +P*C	34	49
		30	1.2	MKP1848Se 630 50 +Y*C	39	40
	24	20	1.0	MKP1848Se 620 50 +P*F	34	63
		30	1.0	MKP1848Se 630 50 +P*F	43	49
		45	1.2	MKP1848Se 645 50 +Y*F	57	35
		75	1.2	MKP1848Se 675 50 +Y6F	108	20
700	12	2	0.8	MKP1848Se 520 70 +K2A	12	99
	15	4	0.8	MKP1848Se 540 70 +K2B	16	90
		6	1.0	MKP1848Se 560 70 +P*B	21	70
		8	1.0	MKP1848Se 580 70 +P*B	25	56
	18	7	1.0	MKP1848Se 570 70 +P*C	21	77
		8	1.0	MKP1848Se 580 70 +P*C	23	70
		12	1.0	MKP1848Se 612 70 +P*C	34	49
	24	15	1.2	MKP1848Se 615 70 +Y*C	41	40
		12	1.0	MKP1848Se 612 70 +P*F	33	63
		18	1.0	MKP1848Se 618 70 +P*F	43	49
		25	1.2	MKP1848Se 625 70 +Y*F	58	35
		50	1.2	MKP1848Se 650 70 +Y6F	105	20
900	12	2	0.8	MKP1848Se 520 90 +K2A	11	99
	15	5	1.0	MKP1848Se 550 90 +P*B	20	70
		7	1.0	MKP1848Se 570 90 +P*B	25	56
	18	5	1.0	MKP1848Se 550 90 +P*C	21	77
		7	1.0	MKP1848Se 570 90 +P*C	23	70
		10	1.0	MKP1848Se 610 90 +P*C	34	49
	24	10	1.0	MKP1848Se 610 90 +P*C	33	63
		15	1.0	MKP1848Se 615 90 +P*F	42	49
20		1.0	MKP1848Se 620 90 +Y*F	59	35	
35	1.2	MKP1848Se 635 90 +Y6F	108	20		
1200	12	1	0.8	MKP1848Se 510 12 +K2A	11	99
	15	2	0.8	MKP1848Se 520 12 +K2B	16	90
	18	3	1.0	MKP1848Se 530 12 +P*C	21	77
		5	1.0	MKP1848Se 550 12 +P*C	33	49
		7	1.0	MKP1848Se 570 12 +Y*C	43	40
	24	7	1.2	MKP1848Se 570 12 +P*F	40	49
		10	1.2	MKP1848Se 610 12 +Y*F	57	35
		12	1.2	MKP1848Se 612 12 +Y*F	56	35
		15	1.2	MKP1848Se 615 12 +Y5F	111	20
		20	1.2	MKP1848Se 620 12 +Y5F	106	20
24	1.2	MKP1848Se 624 12 +Y6F	102	20		

Note

(1) SPQ = Standard Packing Quantity

CONSTRUCTION DESCRIPTION

Low inductive wound cell elements of metallized polypropylene film, potted with resin in a flame retardant case.

SPECIFIC METHOD OF MOUNTING TO WITHSTAND VIBRATION AND SHOCK

The capacitor unit is designed for mounting on a printed circuit board. In order to withstand vibration and shock tests, it must be insured that the stand-off pips are in good contact with the printed circuit board. The capacitors shall be mechanically fixed by the leads and the body clamped.

**SPACE REQUIREMENTS ON PRINTED-CIRCUIT BOARD FOR 2 PINS PRODUCTS**

For the maximum product dimensions and maximum space requirements for length ( $l_{max.}$ ), width ( $w_{max.}$ ), and height ( $h_{max.}$ ) following tolerances must be taken in account in the envelopment of the components as shown in the drawings below.

For products with pitch = 27.5 mm,  $\Delta w = \Delta l = 0.5$  mm, and  $\Delta h = 0.1$  mm;

For products with pitch = 37.5 mm,  $\Delta w = \Delta l = 0.7$  mm, and  $\Delta h = 0.5$  mm;

For products with pitch = 52.5 mm,  $\Delta w = \Delta l = 1.0$  mm, and  $\Delta h = 0.5$  mm.

Eccentricity defined as in drawing. The maximum eccentricity is smaller than or equal to the lead diameter of the product concerned.

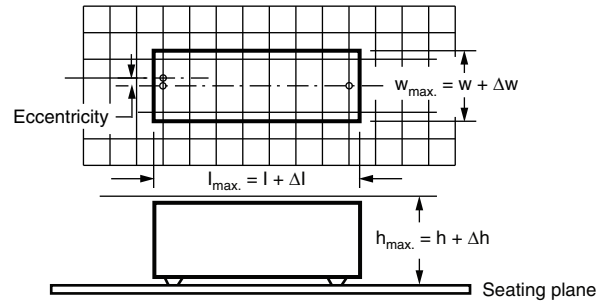

For the minimum product dimensions for length ( $l_{min.}$ ), width ( $w_{min.}$ ), and height ( $h_{min.}$ ) following tolerances of the components are valid:

$l_{min.} = l - \Delta l$ ,  $w_{min.} = w - \Delta w$ , and  $h_{min.} = h - \Delta h$

For products with pitch = 27.5 mm,  $\Delta l = 1.0$  mm, and  $\Delta w = \Delta h = 0.5$  mm;

For products with pitch = 37.5 mm,  $\Delta l = 1.0$  mm, and  $\Delta w = \Delta h = 1.0$  mm;

For products with pitch = 52.5 mm,  $\Delta l = 1.5$  mm, and  $\Delta w = \Delta h = 1.0$  mm.

**SPACE REQUIREMENTS ON PRINTED-CIRCUIT BOARD FOR MULTIPLE PINS PRODUCTS**

The product height with seating plane as given by "IEC 60717" as reference:  $h_{max.} = h$ . The maximum length and width of film capacitors is shown in the figure.

DIMENSIONS in millimeters				
P1	L <sub>max.</sub>	W <sub>max.</sub>	Ø D	H
37.5	$l + 1.5$	$w + 1.8$	1.5	$h + 0.5$
52.5	$l + 1.8$	$w + 2.0$	1.7	$h + 0.5$

**SOLDERING CONDITIONS**

For general soldering conditions and wave soldering profile we refer to the document "Soldering Guidelines for Film Capacitors": [www.vishay.com/doc?28171](http://www.vishay.com/doc?28171)

**STORAGE TEMPERATURE**

$T_{stg} = -25$  °C to  $+35$  °C with relative humidity of maximum 75 % without condensation

**RATINGS AND CHARACTERISTICS REFERENCE CONDITIONS**

Unless otherwise specified, all electrical values apply to an ambient temperature of  $23$  °C  $\pm 1$  °C, an atmospheric pressure of 86 kPa to 106 kPa and a relative humidity of  $50$  %  $\pm 2$  %.

For reference testing, a conditioning period shall be applied over  $96$  h  $\pm 4$  h by heating the products in a circulating air oven at the rated temperature and a relative humidity not exceeding 20 %.



## CHARACTERISTICS

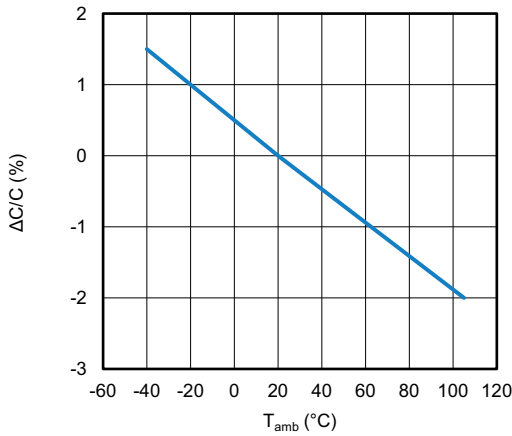

Capacitance as a function of ambient temperature (typical)

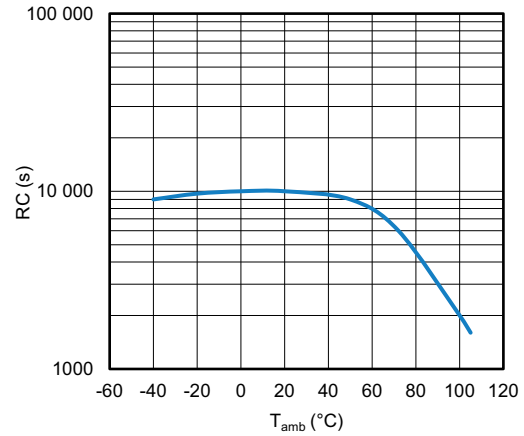

RC as a function of ambient temperature (typical)

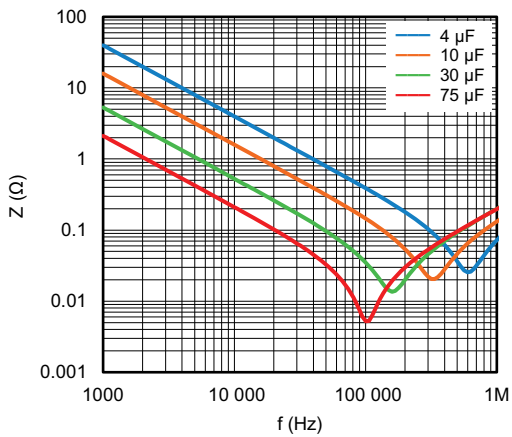

Impedance vs. frequency for 500 V (typical)

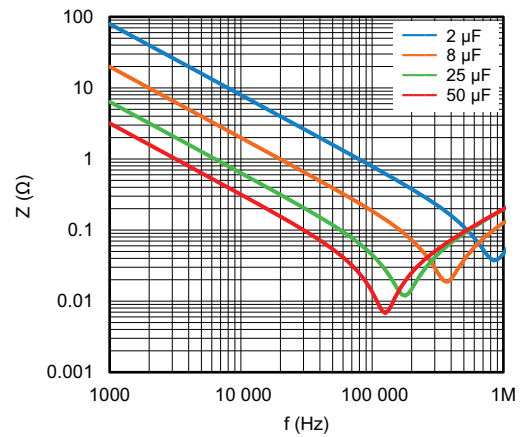

Impedance vs. frequency for 700 V (typical)

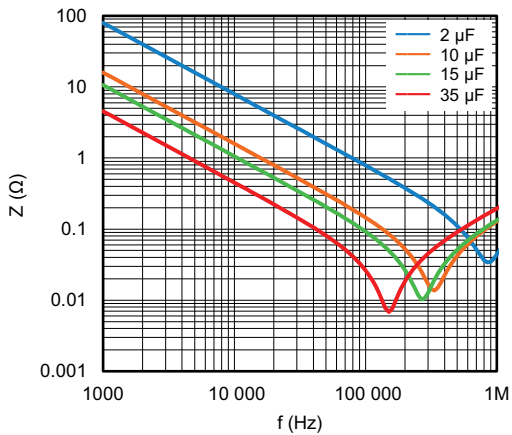

Impedance vs. frequency for 900 V (typical)

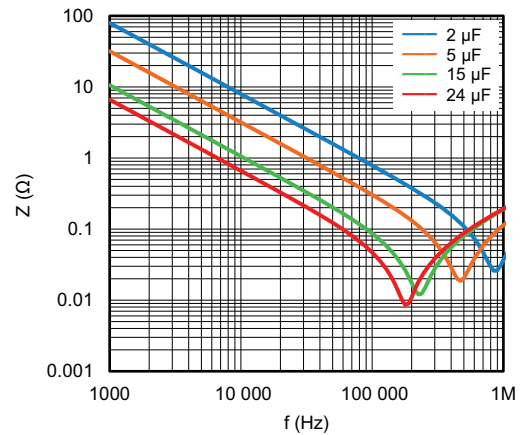

Impedance vs. frequency for 1200 V (typical)

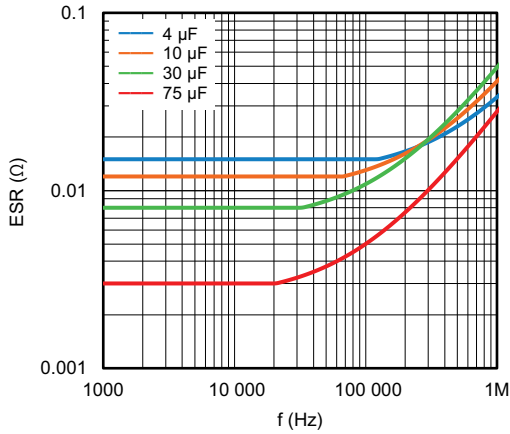

ESR vs. frequency for 500 V (typical)

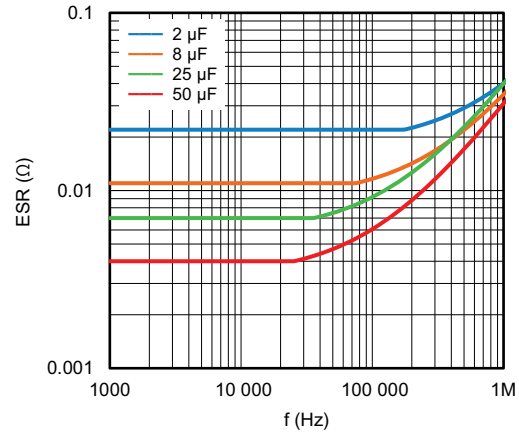

ESR vs. frequency for 700 V (typical)

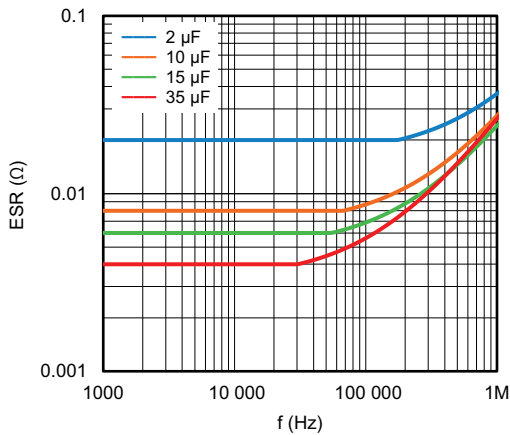

ESR vs. frequency for 900 V (typical)

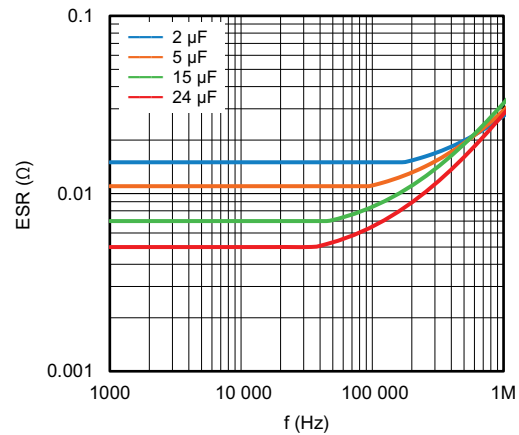

ESR vs. frequency for 1200 V (typical)

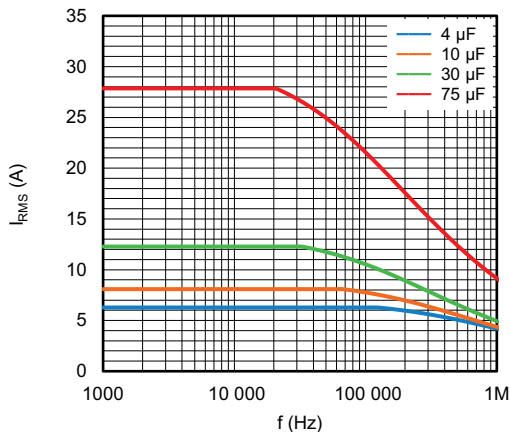

Maximum  $I_{RMS}$  vs. frequency for 500 V, ambient temperature of 85 °C (typical curve)

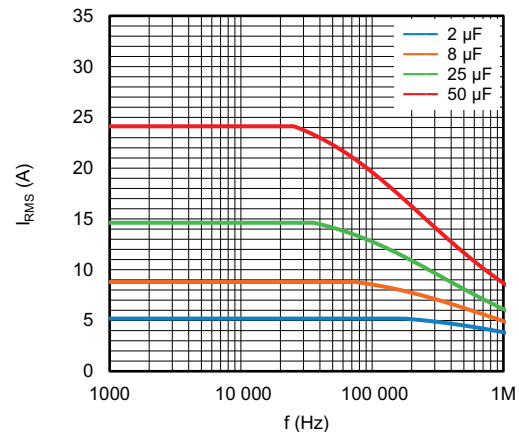

Maximum  $I_{RMS}$  vs. frequency for 700 V, ambient temperature of 85 °C (typical curve)



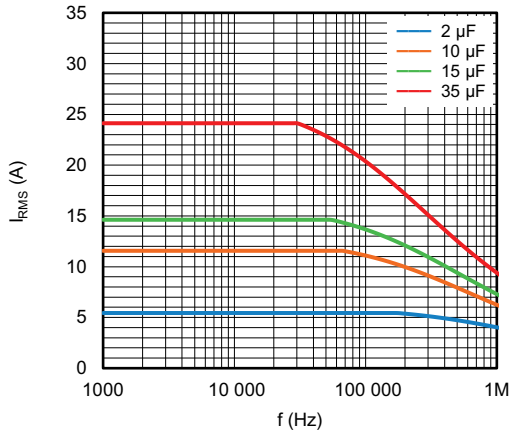

Maximum  $I_{RMS}$  vs. frequency for 900 V, ambient temperature of 85 °C (typical curve)

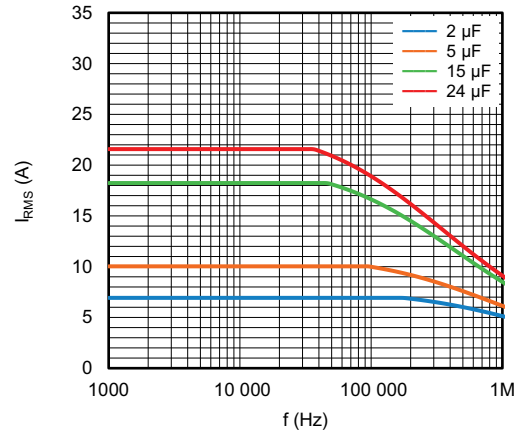

Maximum  $I_{RMS}$  vs. frequency for 1200 V, ambient temperature of 85 °C (typical curve)

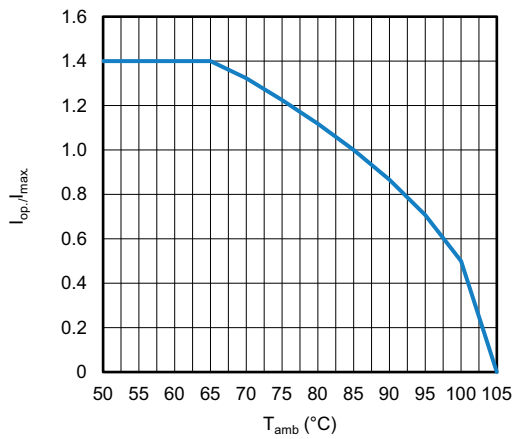

Maximum  $I_{RMS}$  current in function of ambient temperature

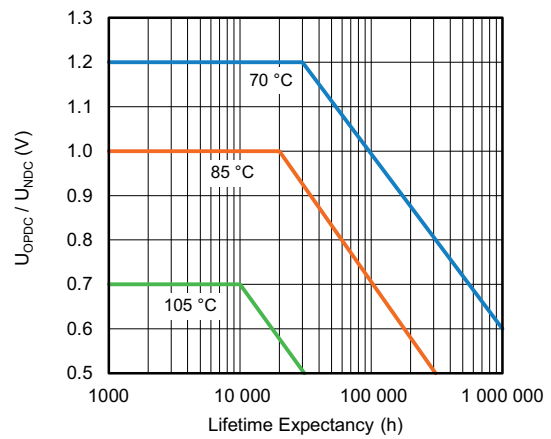

Lifetime expectancy by case temperature

<b>HEAT CONDUCTIVITY</b>			
<b>DIMENSION (mm)</b>			<b>HEAT CONDUCTIVITY (mW/°C)</b>
<b>w</b>	<b>h</b>	<b>l</b>	
24.0	12.0	31.5	39.4
27.0	15.0	31.5	48.0
27.0	15.0	42.0	51.7
33.0	15.0	42.0	59.8
24.0	18.0	42.0	52.3
27.0	18.0	42.0	56.6
39.0	18.0	42.0	73.8
30.0	24.0	42.0	71.3
39.0	24.0	42.0	85.5
35.0	18.0	57.5	80.4
39.0	24.0	57.5	99.8
70.0	24.0	57.5	155.2

### POWER DISSIPATION AND MAXIMUM COMPONENT TEMPERATURE RISE

The power dissipation must be limited in order not to exceed the maximum allowed component temperature rise as a function of the free air ambient temperature.

The component temperature rise ( $\Delta T$ ) can be measured or calculated by  $\Delta T = P/G$ :

- $\Delta T = T_{\text{case}} - T_{\text{ambient}}$  = case temperature rise (°C) with a maximum of 15 °C at rated temperature.
- $P = I_{\text{RMS}}^2 \times \text{ESR}$  = power dissipation of the component (mW)
- $G$  = heat conductivity of the component (mW/°C)

### MEASURING THE COMPONENT TEMPERATURE

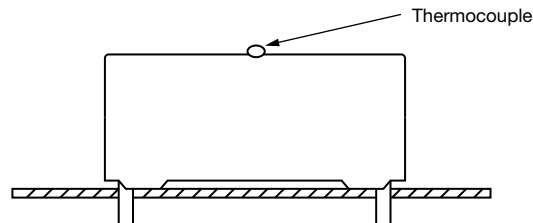

The case temperature is measured in unloaded condition ( $T_{\text{amb}}$ ) and loaded condition ( $T_{\text{C}}$ ).

To avoid external thermal radiation or convection, the capacitor must be tested in a closed area, free from air circulation.

**APPLICATION NOTES AND LIMITING CONDITIONS**

These capacitors are not suitable for mains applications as across-the-line capacitors without additional protection.

These mains applications are strictly regulated in safety standards and therefore electromagnetic interference suppression capacitors conforming the standards must be used.

To select the capacitor for a certain application, the following conditions must be checked:

1. The continuous peak voltage ( $U_{p+}$ ) shall not exceed the DC voltage rating ( $U_{NDC}$ )
2. The peak-to-peak ripple voltage ( $U_{pp}$ ) shall not be greater than  $0.2 \times U_{NDC}$

Non reversing recurrent waveform

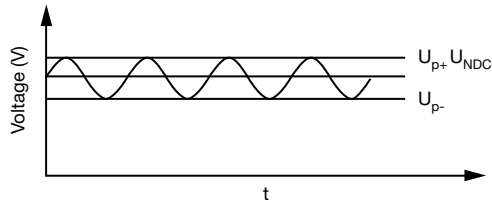

3. For capacitors connected in parallel, normally the proof voltage and possibly the rated voltage must be reduced. For information depending of the capacitance value and the number of parallel connections contact [dc-film@vishay.com](mailto:dc-film@vishay.com).
4. The voltage peak slope ( $dU/dt$ ) shall not exceed the pulse slope at the DC voltage rating.  
If the pulse voltage is lower than the rated DC voltage, the rated voltage pulse slope may be multiplied by  $U_{NDC}$  and divided by the applied voltage.

For all other pulses following equation must be fulfilled:

$$2 \times \int_0^T \left( \frac{dU}{dt} \right)^2 \times dt < U_{NDC} \times \left( \frac{dU}{dt} \right)_{\text{rated}}$$

T is the pulse duration

MAXIMUM REPETITIVE PEAK VOLTAGES	
REPETITIVE SURGE VOLTAGE	MAXIMUM DURATION PER DAY
$1.1 \times U_{NDC}$	30 % of on load duration
$1.15 \times U_{NDC}$	30 min
$1.2 \times U_{NDC}$	5 min
$1.3 \times U_{NDC}$	1 min
$1.5 \times U_{NDC}$	110 ms

**Note**

- The capacitor unit may be subjected to the surge above without any significant reduction of lifetime expectancy



TEST CONDITIONS AND REQUIREMENTS ACCORDING AEC-Q200 REVISION D			
TEST NAME	REFERENCE	TEST CONDITIONS	PERFORMANCE REQUIREMENTS
Pre- and post-stress electrical test	Spec.	-	-
High temperature exposure (storage)	MIL-STD 202 Method 108	105 °C; unpowered; duration: 1000 h	$ \Delta C/C  \leq 3\%$ at 1 kHz Increase of $\tan \delta$ (10 kHz) $\leq 0.0050$ $I_R > 50\%$ of initial specified value
Temperature cycling	JESD22 Method JA-104	1000 cycles: -40 °C / +105 °C 30 min. dwell time at each temperature extreme. Transition time < 1 min.	$ \Delta C/C  \leq 2\%$ at 1 kHz Increase of $\tan \delta$ (10 kHz) $\leq 0.0050$ $I_R > 50\%$ of initial specified value
Moisture resistance	MIL-STD 202 Method 106	10 cycles at 24 h/cycle; unpowered	$ \Delta C/C  \leq 2\%$ at 1 kHz Increase of $\tan \delta$ (10 kHz) $\leq 0.0050$ $I_R > 50\%$ of initial specified value
Biased humidity	MIL-STD 202 Method 103	T = 40 °C, RH = 93 % at $U_{NDC}$ ; Duration: 1000 h	$ \Delta C/C  \leq 5\%$ at 1 kHz Increase of $\tan \delta$ (10 kHz) $\leq 0.0050$ $I_R > 50\%$ of initial specified value
Operational life	MIL-STD 202 Method 108	$T_{amb} = 105\text{ °C}$ ; $U_{NDC}$ ; duration: 1000 h	$ \Delta C/C  \leq 5\%$ at 1 kHz Increase of $\tan \delta$ (10 kHz) $\leq 0.0050$ $I_R > 50\%$ of initial specified value
External visual	MIL-STD 883 Method 2009	Device construction, marking and workmanship	Device construction and workmanship; Legible marking
Dimensions	JESD22 Method JB-100	Measurement of width, height, length, pitch and wire length.	As in datasheet
Terminal strength (lead)	MIL-STD 202 Method 211	Test leaded device for lead integrity only. Pull-test: 44.1 N for 10 s Bend test: 227 g; 90°; 3 cycles of 3 s each	No visual damage
Resistance to solvents	MIL-STD 202 Method 215	Application of Isopropyl alcohol on the marking area.	No visual damage Legible marking
Mechanical shock	MIL-STD 202 Method 213	Pulse: half-sine, 100 g's, 6 ms 6 pulses for each 3 directions	No visual damage
Vibration	MIL-STD 202 Method 204	Profile: 10 Hz to 2000 Hz; 1.5 mm amplitude; 5 g's; 20 min/cycle. 12 cycles for each 3 directions	No visual damage
Resistance to soldering heat	MIL-STD 202 Method 210	280 °C for 10 s	$ \Delta C/C  \leq 0.5\%$ at 1 kHz Increase of $\tan \delta$ (10 kHz) $\leq 0.0050$ $I_R > 50\%$ of initial specified value
Solderability	J-STD-002	Leaded: method A at 235 °C, category 3 (245 °C / 3 s)	No visual damage; solder must present a free flow and adherence.
Electrical characterization	Spec.	-	-
Flammability	UL 94 IEC 60384-1	Flame application with severity according to capacitor's volume	V-0 or V-1 are acceptable Class B acc. IEC is also acceptable



TEST CONDITIONS AND REQUIREMENTS ACCORDING IEC 61071		
NUMBER AND TEST NAME	TEST CONDITIONS	PERFORMANCE REQUIREMENTS
5.5.3-1 Initial measurements	Capacitance at 1 kHz tan δ at 10 kHz Insulation resistance	
5.5.3-2 DC voltage test between terminals	1.5 x U <sub>NDC</sub> at T <sub>amb</sub> , duration 60 s	
5.5.3-3 Final measurements	Capacitance tan δ Insulation resistance	ΔC/C  ≤ 0.5 % Increase of tan δ ≤ 0.0050 Insulation resistance ≥ 50 % of specified values
5.9-1 Initial measurements	Capacitance at 1 kHz tan δ at 10 kHz Insulation resistance	
5.9-2 Surge discharge test	1.1 U <sub>NDC</sub> Number of discharges: 5 Time lapse: every 2 min (10 min total)	
5.9-2 DC voltage test between terminals	Within 5 min after the surge discharge test 1.5 x U <sub>NDC</sub> at T <sub>amb</sub> , duration 60 s	
5.9-3 Final measurements	Capacitance tan δ Insulation resistance	ΔC/C  ≤ 1.0 % tan δ ≤ 1.2 x initial tan δ + 0.0001 Insulation resistance ≥ 50 % of specified values
5.11-1 Initial measurements	Capacitance at 1 kHz tan δ at 10 kHz Insulation resistance	
5.11-2 Self-healing test	1.5 U <sub>NDC</sub> , duration: 10 s Increase the voltage at 100 V/s till 5 clearings occur or until voltage reach max. of 2.5 x U <sub>NDC</sub> , for a duration of 10 s	Number of clearings ≤ 5 Clearing = voltage drop of 5 %
5.11-3 Final measurements	Capacitance tan δ Insulation resistance	ΔC/C  ≤ 1.0 % tan δ ≤ 1.2 x initial tan δ + 0.0001 Insulation resistance ≥ 50 % of specified values
5.13-0 Initial measurements	Capacitance at 1 kHz tan δ at 10 kHz Insulation resistance	
5.13-1 Change of temperature according to IEC 60068-2-14	Test Nb T <sub>max.</sub> = +85 °C; T <sub>min.</sub> = -40 °C Transition time: 1 h, equivalent to 1 °C/min 5 cycles	
5.13.2 Damp heat steady state. According to IEC 60068-2-78	Test Ca T = 40 °C ± 2 °C; RH = 93 % ± 3 % Duration: 56 days	
5.5.3-2 DC voltage test between terminals	1.5 x U <sub>NDC</sub> at ambient temperature; duration: 60 s	
5.13.3 Final measurements	Visual examination Capacitance tan δ Insulation resistance	No puncturing or flashover Self-healing punctures are permitted   ΔC/C  ≤ 2.0 % Increase of tan δ ≤ 0.0150 Insulation resistance ≥ 50 % of specified values



TEST CONDITIONS AND REQUIREMENTS ACCORDING IEC 61071		
NUMBER AND TEST NAME	TEST CONDITIONS	PERFORMANCE REQUIREMENTS
5.15-0 Initial measurements	Capacitance at 1 kHz tan δ at 10 kHz Insulation resistance	
5.15-1 Endurance test between terminals	Sequences:  1.3 x U <sub>NDC</sub> at 85 °C; duration: 500 h 1000 x discharge at 1.4 x $\hat{I}$ (maximum peak current) 1.3 x U <sub>NDC</sub> at 85 °C; duration: 500 h  1.3 x U <sub>OPDC</sub> at 105 °C; duration: 500 h 1000 x discharge at 1.4 x $\hat{I}$ (maximum peak current) 1.3 x U <sub>OPDC</sub> at 105 °C; duration: 500 h	
5.15-2 Final measurements	Capacitance tan δ Insulation resistance	$ \Delta C/C  \leq 3 \%$ Increase of tan δ ≤ 0.0150 Insulation resistance ≥ 50 % of specified values
5.16.3-0 Initial measurements	Capacitance at 1 kHz	
5.16.3-1 Destruction test sequence for non-segmented film	The capacitors must be put in an oven at T <sub>max.</sub> = 85 °C, product enveloped with cheese cloth	Audible healings or check healings with oscilloscope
High DC voltage test	3 x U <sub>NDC</sub> or DC voltage until repetitive product healings occur, duration = 15 min	
High AC voltage test	AC <sub>RMS</sub> voltage = U <sub>NDC</sub> / $2\sqrt{2}$ , with min. 250 V <sub>AC</sub> Duration = 5 min  Repeat destruction sequence 3 x	
5.16.3-2 Final measurements	Visual examination	No puncturing, flashover or burning of the cheese cloth. Self-healing punctures are permitted

ADDITIONAL TEST AND REQUIREMENTS		
NUMBER AND TEST NAME	TEST CONDITIONS	PERFORMANCE REQUIREMENTS
5.13A-0 Initial measurements	Capacitance at 1 kHz tan δ at 10 kHz Insulation resistance	
5.13A.2 Damp heat steady state with load	T = 60 °C; RH = 93 % at U <sub>NDC</sub> Duration: 56 days	
5.13.3 Final measurements	Capacitance at 1 kHz tan δ Insulation resistance	$ \Delta C/C  < 5 \%$ Increase of tan δ ≤ 0.0500 Insulation resistance ≥ 100 MΩ



## Disclaimer

ALL PRODUCT, PRODUCT SPECIFICATIONS AND DATA ARE SUBJECT TO CHANGE WITHOUT NOTICE TO IMPROVE RELIABILITY, FUNCTION OR DESIGN OR OTHERWISE.

Vishay Intertechnology, Inc., its affiliates, agents, and employees, and all persons acting on its or their behalf (collectively, "Vishay"), disclaim any and all liability for any errors, inaccuracies or incompleteness contained in any datasheet or in any other disclosure relating to any product.

Vishay makes no warranty, representation or guarantee regarding the suitability of the products for any particular purpose or the continuing production of any product. To the maximum extent permitted by applicable law, Vishay disclaims (i) any and all liability arising out of the application or use of any product, (ii) any and all liability, including without limitation special, consequential or incidental damages, and (iii) any and all implied warranties, including warranties of fitness for particular purpose, non-infringement and merchantability.

Statements regarding the suitability of products for certain types of applications are based on Vishay's knowledge of typical requirements that are often placed on Vishay products in generic applications. Such statements are not binding statements about the suitability of products for a particular application. It is the customer's responsibility to validate that a particular product with the properties described in the product specification is suitable for use in a particular application. Parameters provided in datasheets and / or specifications may vary in different applications and performance may vary over time. All operating parameters, including typical parameters, must be validated for each customer application by the customer's technical experts. Product specifications do not expand or otherwise modify Vishay's terms and conditions of purchase, including but not limited to the warranty expressed therein.

Hyperlinks included in this datasheet may direct users to third-party websites. These links are provided as a convenience and for informational purposes only. Inclusion of these hyperlinks does not constitute an endorsement or an approval by Vishay of any of the products, services or opinions of the corporation, organization or individual associated with the third-party website. Vishay disclaims any and all liability and bears no responsibility for the accuracy, legality or content of the third-party website or for that of subsequent links.

Except as expressly indicated in writing, Vishay products are not designed for use in medical, life-saving, or life-sustaining applications or for any other application in which the failure of the Vishay product could result in personal injury or death. Customers using or selling Vishay products not expressly indicated for use in such applications do so at their own risk. Please contact authorized Vishay personnel to obtain written terms and conditions regarding products designed for such applications.

No license, express or implied, by estoppel or otherwise, to any intellectual property rights is granted by this document or by any conduct of Vishay. Product names and markings noted herein may be trademarks of their respective owners.