

---

## 3-Phase 1200V/340A SiC MOSFET Intelligent Power Module CXT-PLA3SA12340A-Preliminary Datasheet

---

Version: 1.7

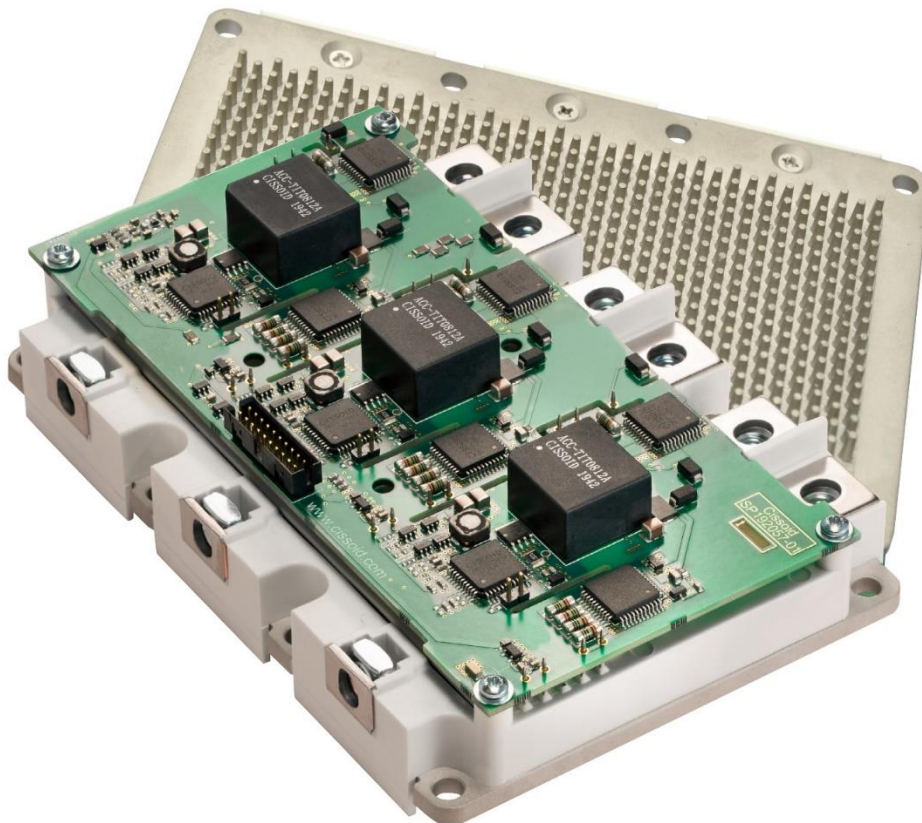
### General description

CXT-PLA3SA12340A is a 3-phase 1200V/340A SiC MOSFET Intelligent Power Module integrating the power switches and the gate driver based on CISSOID HADES2® chipset.

With its **pin fin baseplate**, this module addresses high power density water cooled converters offering a SiC power module designed for operation at high junction temperature (up to 175°C). This solution gives access to the full benefits of SiC technology

to achieve high power density thanks to low switching losses and high temperature operation.

The integration of the gate driver together with the power module give direct access to a fully validated and optimized solution in terms of switching speed and losses, robustness against  $dI/dt$  and  $dV/dt$  and protection of the power stages (Desat, UVLO, AMC, SSD).



### Key Features

- VDS breakdown voltage: 1200V
- Low  $R_{DS(on)}$ <sup>1</sup>: typ 4.19m $\Omega$
- Max Continuous current:
  - 340A typ. @ Tf=25°C
  - 260A typ. @ Tf=90°C
- Thermal resistance (J2C):
  - 0.167 °C/W typ.
- Max 175°C operating junction temperature (power devices)
- Switching Energy @ 600V/300A:
  - Eon: 7.48 mJ
  - Eoff: 7.39 mJ
- Switching frequency: 25kHz Max
- Isolation (baseplate – power pins):
  - 3600VAC @50Hz (1min)
- Common mode transient immunity:
  - >50kV/ $\mu$ s
- Dimensions:
  - 104(W) x 154(L) X 34(H) (all in mm)
- Weight: 590g
- Single power supply (VCC):
  - +12V to +18V
- Max 125°C operating ambient temperature (gate driver)
- Isolation (primary – secondary):
  - 3600VAC @50Hz (1min)
- Parasitic capacitance:
  - typ 11pF per phase
- PWM input signal
  - 5V Schmitt trigger input
  - Active-High (Active-Low as an option)
- Open-drain fault reporting:
  - per phase
  - per side as an option
- Turn-On/Off delay: 180ns typ.
- Under voltage lockout (UVLO)
  - On VCC
  - On internally generated secondary supplies
- Desaturation protection
- Soft Shutdown turn-off (SSD)
- Negative gate drive (-3V)
- Active Miller Clamping (AMC)
- Gate-Source Short-circuit Protection

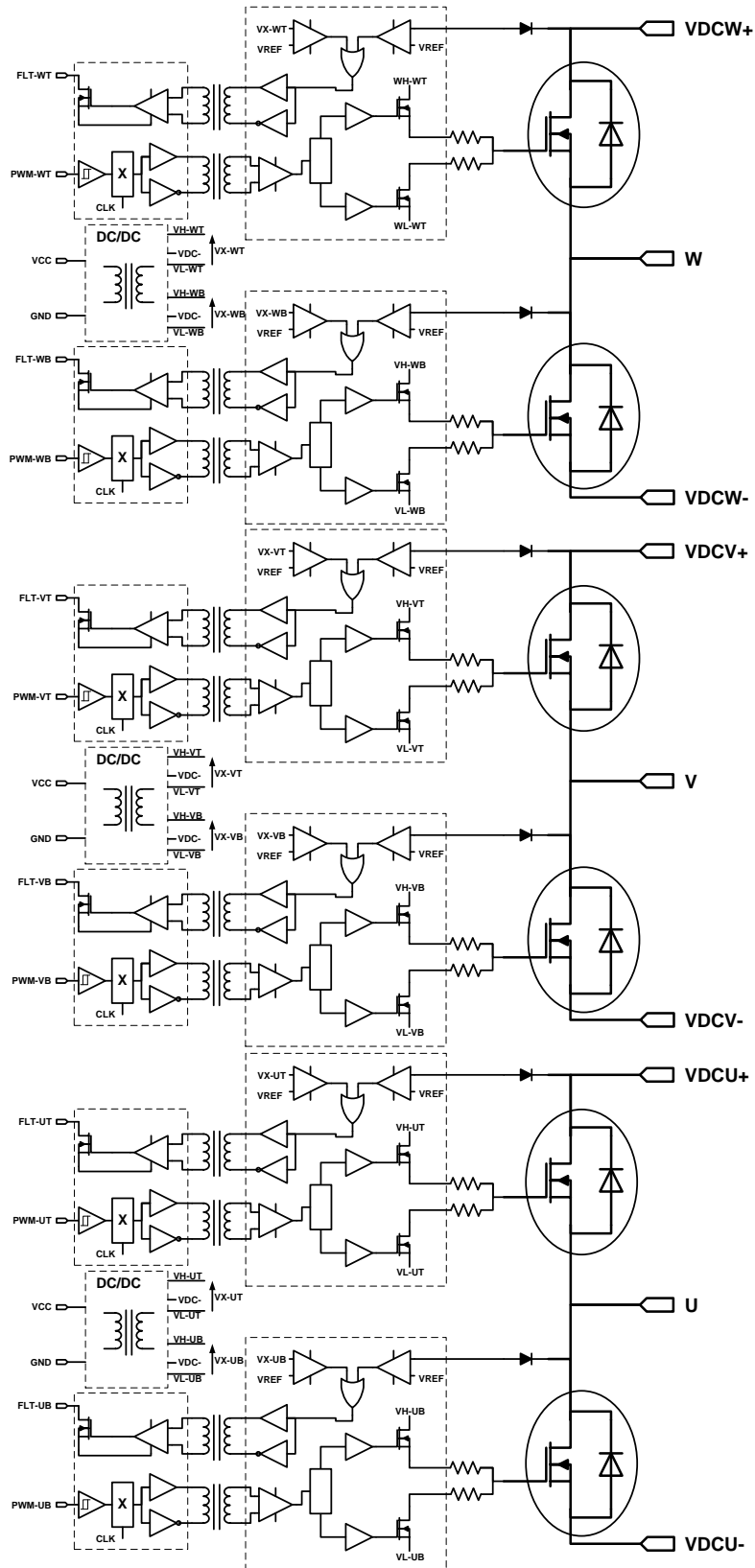
### Ordering Information

Product Name	Ordering Reference	Marking
CXT-PLA3SA12340A	CXT-PLA3SA12340AA	CXT-PLA3SA12340AA

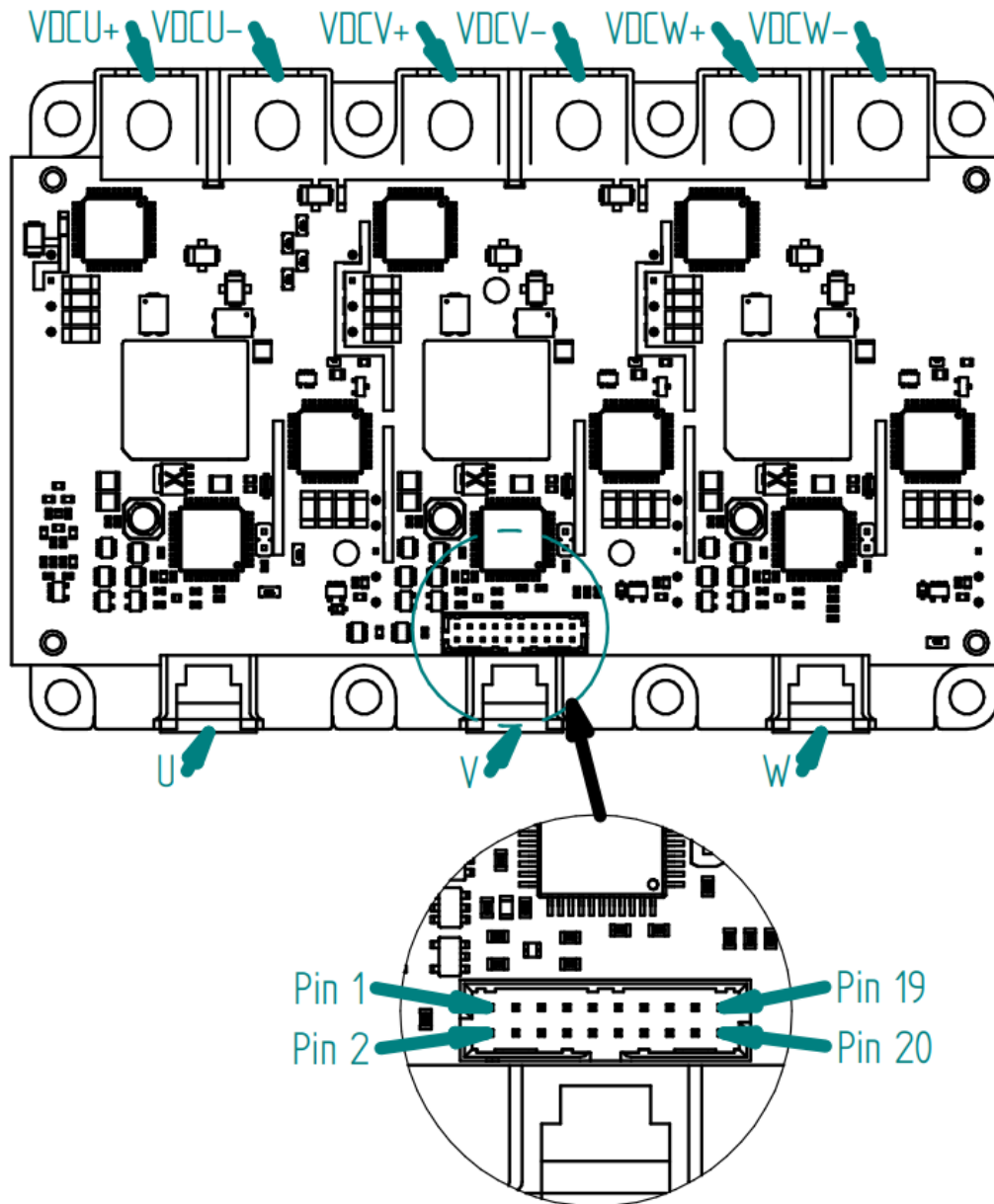
---

<sup>1</sup> Package resistance excluded

#### Block diagram



#### Pinout<sup>2</sup>



<sup>2</sup> "VDCU+, VDCV+, VDCW+", "VDCU-, VDCV-, VDCW-" are not connected to each other internally

**Pinout (cnt'd)**

Interface	Pin	Pin name	Description
<b>POWER</b>		<b>VDCU+</b>	U Phase positive power supply
		<b>VDCU-</b>	U Phase negative power supply
		<b>VDCV+</b>	V Phase positive power supply
		<b>VDCV-</b>	V Phase negative power supply
		<b>VDCW+</b>	W Phase positive power supply
		<b>VDCW-</b>	W Phase negative power supply
		<b>U</b>	Half-Bridge output U
		<b>V</b>	Half-Bridge output V
		<b>W</b>	Half-Bridge output W

<b>CONTROL</b>	<b>Pin 1</b>	<b>PWM-UT</b>	PWM input high-side phase U
	<b>Pin 2</b>	<b>PWM-UB</b>	PWM input low-side phase U
	<b>Pin 3</b>	<b>TEMP-U</b>	Phase U temperature measurement output
	<b>Pin 4</b>	<b>RSTN</b>	Reset signal (active low); while low, forces all PWM to inactive state
	<b>Pin 5</b>	<b>PWM-VT</b>	PWM input high-side phase V
	<b>Pin 6</b>	<b>VDCM</b>	DC BUS voltage monitoring output
	<b>Pin 7</b>	<b>PWM-VB</b>	PWM input low-side phase V
	<b>Pin 8</b>	<b>GND</b>	Gate driver negative power supply
	<b>Pin 9</b>	<b>FLT-T-V</b>	Phase V fault output or 3 phase high-side fault output
	<b>Pin 10</b>	<b>GND</b>	Gate driver negative power supply
	<b>Pin 11</b>	<b>FLT-B-U</b>	Phase U fault output or 3 phase low-side fault output
	<b>Pin 12</b>	<b>VCC</b>	Gate driver positive power supply
	<b>Pin 13</b>	<b>TEMP-V</b>	Phase V temperature measurement output
	<b>Pin 14</b>	<b>VCC</b>	Gate driver positive power supply
	<b>Pin 15</b>		
	<b>Pin 16</b>	<b>GND</b>	Gate driver negative power supply
	<b>Pin 17</b>	<b>FLT-W</b>	Phase W fault output
	<b>Pin 18</b>	<b>TEMP-W</b>	Phase W temperature measurement output
	<b>Pin 19</b>	<b>PWM-WT</b>	PWM input high-side phase W
	<b>Pin 20</b>	<b>PWM-WB</b>	PWM input low-side phase W

## Max Absolute Ratings

### “SiC Power MOSFET’s”

Parameter	Symbol	Condition	Value	Unit
Drain – Source Voltage	V <sub>DS</sub>	T <sub>j</sub> =25°C	1200	V
		T <sub>j</sub> =175°C	1200	V
MOSFET Continuous Drain Current	I <sub>D</sub>	V <sub>GS</sub> =15V, T <sub>C</sub> =25°C, T <sub>j</sub> <175°C	340	A
		V <sub>GS</sub> =15V, T <sub>C</sub> =90°C, T <sub>j</sub> <175°C	260	A
Pulsed Drain Current	I <sub>Dpulse</sub>	pulse width t <sub>p</sub> limited by T <sub>jmax</sub>	720	A
Junction temperature	T <sub>j</sub>		175°C	°C
Case and Storage temperatures	T <sub>C</sub> , T <sub>STG</sub>		-40°C to 150°C	°C
Stray Inductance	L <sub>Stray</sub>	Between VDCX+ and VDCX-	12.5	nH
Package resistance @ 25°C <sup>3</sup>		Between VDCX+ and phase output	0.7	mΩ
		Between VDCX- and phase output	0.7	mΩ
Clearance distance		From VDCX+ to VDCX-	5.6	mm
		From U,V,W to Baseplate	12	mm
		From VDCX+,VDCX- to Baseplate	12.5	mm
		From Gate driver HS,LS to Primary	6	mm
		From Gate driver Primary to U,V,W	7.63	mm
		From Gate driver HS,LS to VDCX+,VDCX-	7.93	mm
Creepage distance		From VDCX+ to VDCX-	5.6	mm
		From U,V,W to Baseplate	12	mm
		From VDCX+,VDCX- to Baseplate	12.5	mm
		From Gate driver HS,LS to Primary	6	mm
		From Gate driver Primary to U,V,W	>15	mm
		From Gate driver HS,LS to VDCX+,VDCX-	>15	mm
CTI-Comparative Tracking Index		Power module	min 175	
Mounting Torque	M <sub>P</sub>	Terminals VDCX+, VDCX-, U,V,W	4	N-m
	M <sub>BP</sub>	Baseplate	2	N-m
Weight	g		590	g

<sup>3</sup> Package resistance temperature coefficient: 0.39%/°C

### Max Absolute Ratings

#### “Gate Driver”

Parameter	Min.	Max.	Units
VCC-GND	-0.5	18	V
PWM-XT/PWM-XB/RSTN wrt GND	-0.5V	5.5	V
FLT-B-U/ FLT-T-V/FLT-W wrt GND	-0.5V	18	V
CTI-Comparative Tracking Index	175		
Junction Temperature		175	°C
Storage and Operating Temperature	-40	125	°C
ESD Rating (Human Body Model) between VCC/GND/PWM-XT/PWM-XB/RSTN/FLT-X pins <sup>4</sup>	1.5		kV

### Isolation

Parameter	Condition	Min.	Typ.	Max.	Units
VDCX+/VDCX-/U/V/W wrt to VCC/GND/PWM-XT/PWM-XB/FLT-X	AC @50Hz (for 1mn)		3600		V
Any of “VDCX+/VDCX-/U/V/W/VCC/GND/PWM-XT/PWM-XB/FLT-X wrt to baseplate	@ 1000VDC		>1		GΩ
Parasitic capacitance	Between high-side and primary (per phase)		11		pF

### DC Bus Voltage Monitoring

Parameter	Symbol	Condition	Typ	Unit
DC BUS voltage monitoring output	VDCM		0.0033*Diff(VDCV+,VDCU-)	V

### Temperature Monitoring

Parameter	Symbol	Condition	Typ	Unit
Temperature monitoring output	TEMP-U TEMP-V TEMP-W		$NTC_{R(Ohm)} * 5 / (NTC_{R(Ohm)} + 1500)$	V
NTC resistance	NTC <sub>R</sub>	T <sub>NTC</sub> =25°C	5000	Ω

Steinhart-Hart Coefficients for NTC<sub>R</sub> versus Temperature computation:

$$1/(T_{NTC}-273.15) = A+B*\ln(R)+C*\ln^3(R)$$

	A	B	C
T <sub>NTC</sub> < (273.15+25)K	9.931*10 <sup>-4</sup>	2.658*10 <sup>-4</sup>	1.563*10 <sup>-7</sup>
T <sub>NTC</sub> > (273.15+25)K	9.923*10 <sup>-4</sup>	2.664*10 <sup>-4</sup>	1.496*10 <sup>-7</sup>

<sup>4</sup> Because of functional isolation requirement between «VDCX+/VDCX-/U/V/W» and «VCC/GND/PWM-XT/PWM-XB/FLT-X» pins, no ESD performance can be guaranteed between those 2 pin groups.

### Electrical Characteristics "Power module"

Unless otherwise stated: (VCC-GND)=15V,  $T_C=25^{\circ}\text{C}$ . **Bold underlined> values indicate values over the whole temperature range ( $-40^{\circ}\text{C} < T_J < +175^{\circ}\text{C}$ ).**

#### "SiC Power MOSFET's"

Parameter	Symbol	Condition	Min	Typ	Max	Unit	
Threshold voltage	$V_{TH}$	$T_J=25^{\circ}\text{C}$ ; $I_{DS} = 0.02\text{A}$ ; $V_{DS} = V_{GS}$	1.8	2.2	3.5	V	
		$T_J=175^{\circ}\text{C}$ ; $I_{DS} = 0.02\text{A}$ ; $V_{DS} = V_{GS}$		1.66		V	
Drain cut-off current	$I_{DSS}$	$V_{GS} = -3\text{V}$ , $V_{DS} = 1200\text{V}$ , $T_J=25^{\circ}\text{C}$		1		$\mu\text{A}$	
		$V_{GS} = -3\text{V}$ , $V_{DS} = 1200\text{V}$ , $T_J=175^{\circ}\text{C}$		50		$\mu\text{A}$	
Static drain-to-source resistance <sup>5</sup>	$R_{DSon}$	$V_{GS} = 15\text{V}$ , $I_D = 300\text{A}$ , $T_J=25^{\circ}\text{C}$		4.19	5.15	$\text{m}\Omega$	
		$V_{GS} = 15\text{V}$ , $I_D = 300\text{A}$ , $T_J=175^{\circ}\text{C}$		7.64		$\text{m}\Omega$	
Breakdown drain-to-source voltage (DC characterization)	$V_{BRDS}$	$V_{GS} = -3\text{V}$ ; $I_{DS} = 500 \mu\text{A}$	<b>1200</b>			V	
Input capacitance	$C_{ISS}$	$V_{GS} = 0\text{V}_{DC}$ , $V_{DS} = 600\text{V}_{DC}$		24		nF	
Output capacitance	$C_{OSS}$	$f = 100 \text{ kHz}$		1		nF	
Feedback capacitance	$C_{RSS}$	$V_{AC} = 25\text{mV}$		55		pF	
Turn-on delay time	$T_{d(ON)}$	$V_{DS} = 600\text{V}$ ; $V_{GS} = -3/15\text{V}$ ; $I_{DS} = 300\text{A}$ ; $L = 50\mu\text{H}$		65		ns	
Rise time	$T_r$			96		ns	
Turn-off delay time	$T_{d(OFF)}$			190		ns	
Fall time	$T_f$			38		ns	
Turn-On Switching Energy	$E_{on}$			7.48		mJ	
Turn-Off Switching Energy	$E_{off}$			7.39		mJ	
Gate to Source Charge	$Q_{GS}$		$T_J=25^{\circ}\text{C}$ ; $V_{DS} = 600\text{V}$ ;		218		nC
Gate to Drain Charge	$Q_{GD}$		$I_{DS} = 300\text{A}$ ; $V_{GS} = -3/15\text{V}$		213		nC
Total Gate Charge	$Q_G$				682		nC
Short-circuit protection threshold	$I_{Scth}$		$T_J=25^{\circ}\text{C}$		888		A
		$T_J=175^{\circ}\text{C}$		513		A	
Maximum short-circuit duration	tsc			2		$\mu\text{s}$	

#### "SiC Reverse Diode"

Parameter	Symbol	Condition	Min	Typ	Max	Unit
Diode Forward Voltage	$V_F$	$T_J=25^{\circ}\text{C}$ ; $I_{SD} = 300\text{A}$ ; $V_{GS} = -3\text{V}$		5.18		V
		$T_J=175^{\circ}\text{C}$ ; $I_{SD} = 300\text{A}$ ; $V_{GS} = -3\text{V}$		4.55		V
Continuous Diode Forward Current	$I_{SD,DC}$	$V_{GS} = -3\text{V}$ , $T_f=25^{\circ}\text{C}$ , $T_J < 175^{\circ}\text{C}$		200		A
Diode Pulse Current	$I_{SD, Pulse}$	$V_{GS} = -3\text{V}$ , pulse width $t_p$ limited by $T_{jmax}$		720		A
Reverse Recovery Time	$t_{RR}$	$V_{DS} = 600\text{V}$ ; $V_{GS} = -3\text{V}$ ; $I_{SD} = 300\text{A}$ $T_J=25^{\circ}\text{C}$ ; $L = 50\mu\text{H}$ ; $dI/dt = 9\text{A/ns}$		28		ns
Reverse Recovery Charge	$Q_{RR}$			1.43		$\mu\text{C}$
Peak Reverse Recovery Current	$I_{RR}$			79		A
Reverse Recovery Energy	$E_{RR}$			0.27		mJ

### Thermal Characteristics

Parameter	Symbol	Condition	Min	Typ	Max	Unit
Junction-to-Fluid Thermal resistance <sup>6</sup>	$\Theta_{JF}$	Each switch position		0.209		$^{\circ}\text{C/W}$
Junction-to-Case Thermal resistance	$\Theta_{JC}$	Each switch position		0.167		$^{\circ}\text{C/W}$
Operating Junction Temperature					<b>175</b>	$^{\circ}\text{C}$

<sup>5</sup>  $R_{DSon}$  does not include package resistance; see section Max Absolute Ratings for information about package resistance

<sup>6</sup> Measurement conditions: Flow rate: 10l/min; 50% ethylene glycol, 50% water, 75 $^{\circ}\text{C}$  inflow temperature. Reference cooler design available upon request.



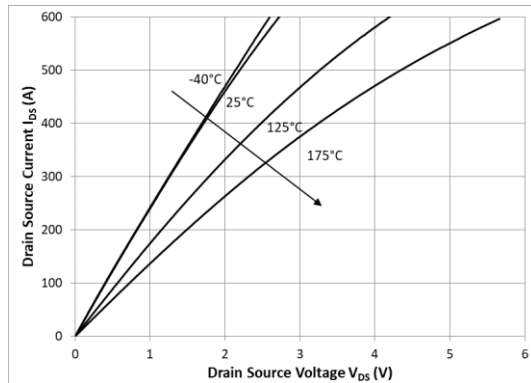
## 3-Phase 1200V/340A SiC MOSFET Intelligent Power Module Preliminary Datasheet

### Electrical Characteristics “Gate Driver”

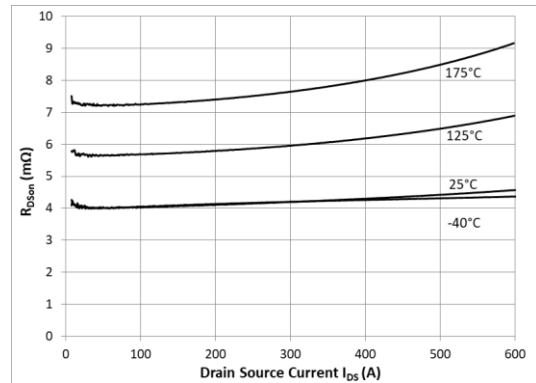
Unless otherwise stated: (VCC-GND)=15V,  $T_C=25^{\circ}\text{C}$ . **Bold underlined** values indicate values over the whole temperature range ( $-40^{\circ}\text{C} < T_J < +175^{\circ}\text{C}$ ).

Parameter	Condition	Min	Typ	Max	Units
<b>Gate driver power supply</b>					
VCC		<b>12</b>	<b>15</b>	<b>18</b>	V
I <sub>VCC</sub>	0 kHz PWM; VCC=15V		163		mA
	25 kHz PWM; VCC=15V; VDCX+ = 0V		341		mA
	25 kHz PWM; VCC=15V; VDCX+ = 600V;		402		mA
<b>PWM-XL/PWM-XH/RSTN inputs</b>					
V <sub>IH</sub>	Applies to PWM-XB/PWM-XT/RSTN		3.5		V
V <sub>IL</sub>			1.6		V
Hysteresis			1.9		V
Pull-down impedance (PWM-XB/PWM-XT)/ pull-up impedance (RSTN)			2		kΩ
<b>FLT-X open drain outputs</b>					
On resistance				<b>25</b>	Ω
Voltage on FLT-X				<b>18</b>	V
Internal pull-up resistance	Connected between FLT-X and VCC		10		kΩ
Minimum external pull-up resistance			300		Ω
Output Fall Time (90% to 10%)	On 50 pF external capacitance External pull-up: 300 Ohm to VCC		36		ns
<b>Non-overlap delay (NOV_D)</b>					
Non Overlap delay HIGH => LOW	In Local Mode (JP1="ON")		400		ns
Non Overlap delay LOW => HIGH	Measured at power switch gate		350		ns
<b>PWM data path</b>					
PWM frequency				<b>25</b>	kHz
Duty cycle		<b>0</b>		<b>100</b>	%
Anti-glitch filter window			500		ns
Propagation delay (PWM-XB/PWM-XT → U/V/W) (50% to 10%)	Direct Mode; excluding anti-glitch filter delay		180		ns
Propagation delay (PWM-XB/PWM-XT → U/V/W) (50% to 10%)	Local Mode; excluding anti-glitch filter delay		600		ns
<b>Fault latching time</b>					
Timer value (Primary or Secondary faults)			14		ms
Timer variation		-30		+25	%
<b>Under-voltage Lockout on VCC (UVLO_P)</b>					
UVLO_P High Threshold			9.75		V
UVLO_P Low Threshold			8.2		V
Delay from UVLO_P detection to FLT-X @ fault level			200		ns
<b>Under-voltage Lockout on secondaries gate driver supplies(UVLO_S)</b>					
UVLO_S High Threshold			16.8		V
UVLO_S Low Threshold			15.5		V
Delay from UVLO_S detection to FLT-X @ fault level			600		ns
<b>Desaturation detection (DESAT_H, DESAT_L)</b>					
Desaturation Threshold	wrt to power switch source		4.6		V
Desaturation Blanking time			1		μs
Delay from Desaturation detection to FLT-X in fault state			600		ns
Soft Shutdown gate fall time	V <sub>GS</sub> from 15V to 0V		1		μs

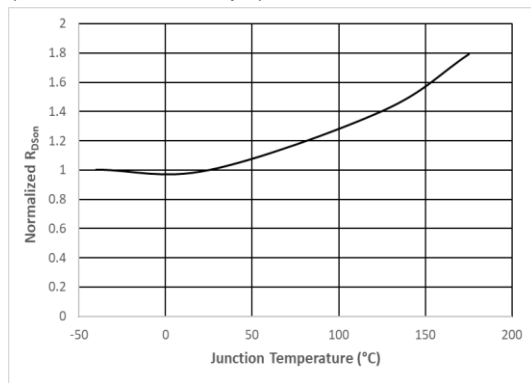
## Typical performances (per switch)



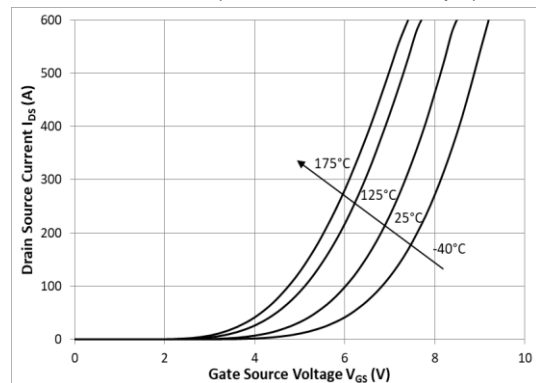
**Figure 1:** Drain current vs  $V_{DS}$   
( $V_{GS}=15V$ ,  $t_p < 200\mu s$ )<sup>7</sup>



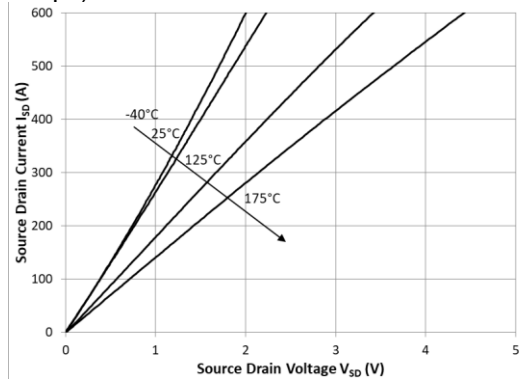
**Figure 2:** On-state drain source resistance vs. Drain current ( $V_{GS} = 15V$ ,  $t_p < 200\mu s$ )<sup>7</sup>



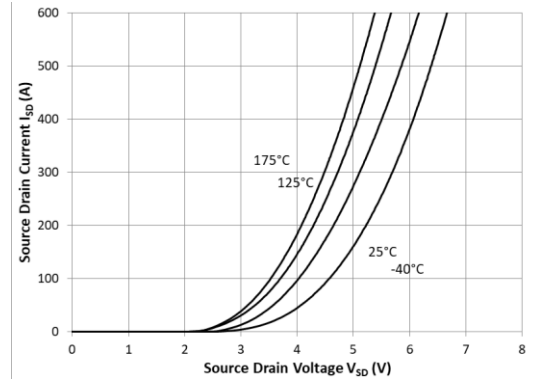
**Figure 3:** Normalized on-state drain source resistance ( $I_{DS}=300A$ ,  $V_{GS} = 15V$ ,  $t_p < 200\mu s$ )<sup>7</sup>



**Figure 4:** Drain current vs  $V_{GS}$  voltage  
( $V_{DS}=20V$ ,  $t_p < 200\mu s$ )



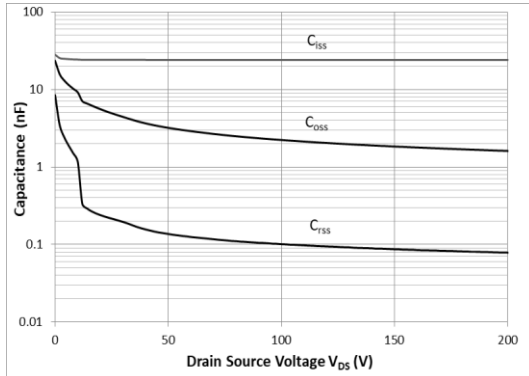
**Figure 5 :** 3rd quadrant characteristics  
( $V_{GS}=15V$ ,  $t_p < 200\mu s$ )<sup>7</sup>



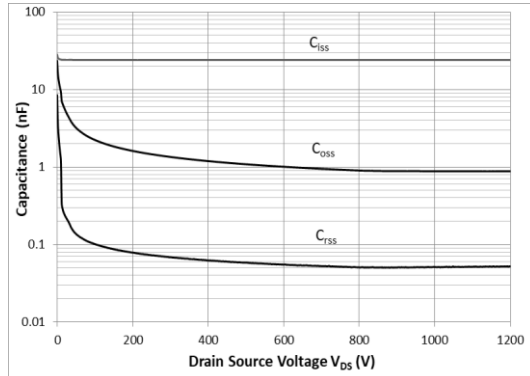
**Figure 6:** 3rd quadrant characteristics  
( $V_{GS}=-3V$ ,  $t_p < 200\mu s$ )<sup>7</sup>

<sup>7</sup> Package resistance excluded

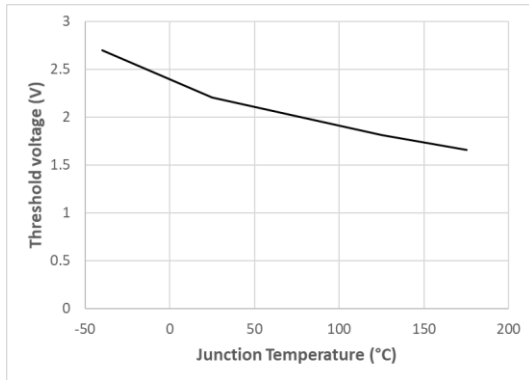
## Typical performances (per switch) (cnt'd)



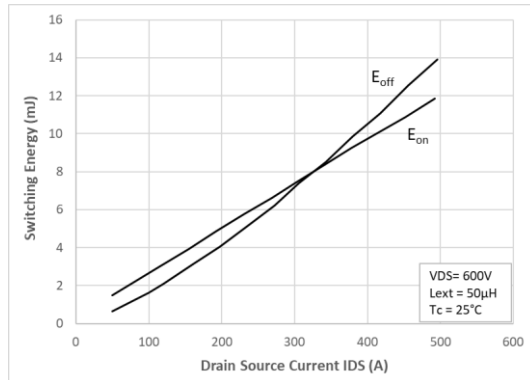
**Figure 7:** Typical capacitances vs  $V_{DS}$   
( $T_j=25^\circ\text{C}$  ;  $f = 100 \text{ kHz}$ ,  $V_{AC} = 25\text{mV}$ )



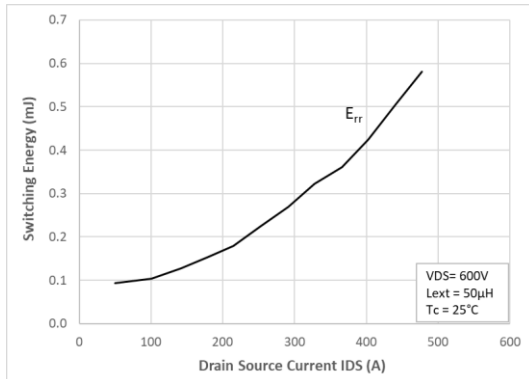
**Figure 8 :** Typical capacitances vs  $V_{DS}$   
( $T_j=25^\circ\text{C}$  ;  $f = 100 \text{ kHz}$ ,  $V_{AC} = 25\text{mV}$ )



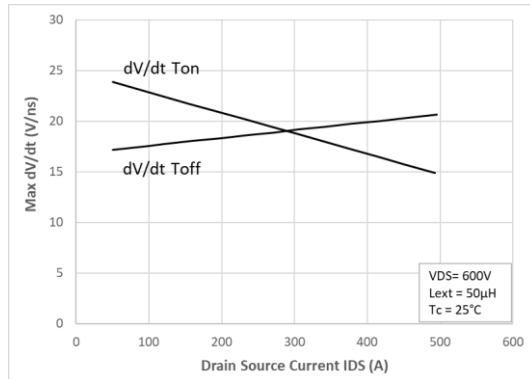
**Figure 9:** Threshold vs temp ( $I_{DS}=20\text{mA}$ ;  $V_{GS}=V_{DS}$ )



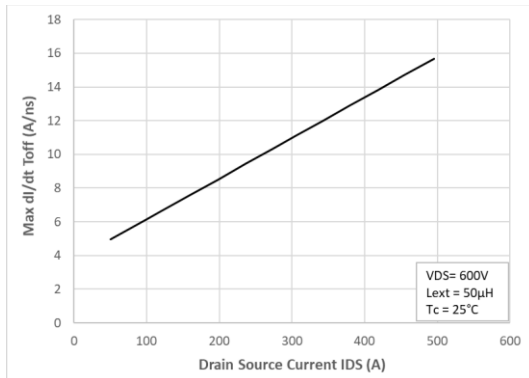
**Figure 10 :** Switching Energy



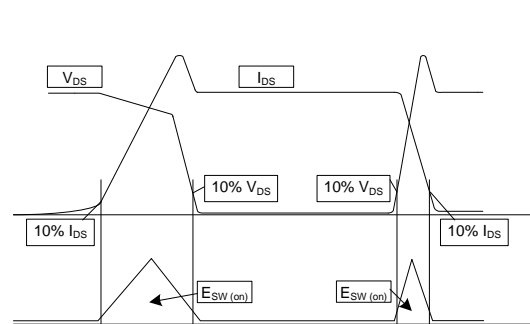
**Figure 11 :** Reverse Recovery Energy



**Figure 12 :** Max  $dV/dt$  vs Drain current

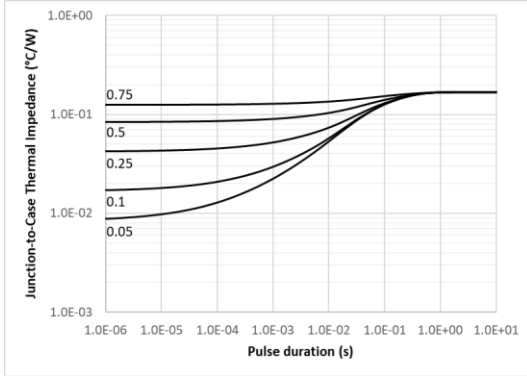


**Figure 13 :** Max Turn-off  $dI/dt$  vs Drain current

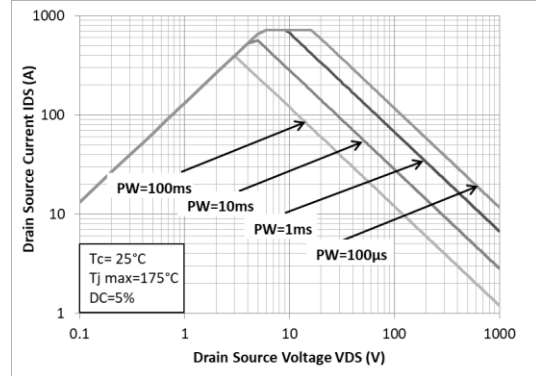


**Figure 14 :** Switching energy computation

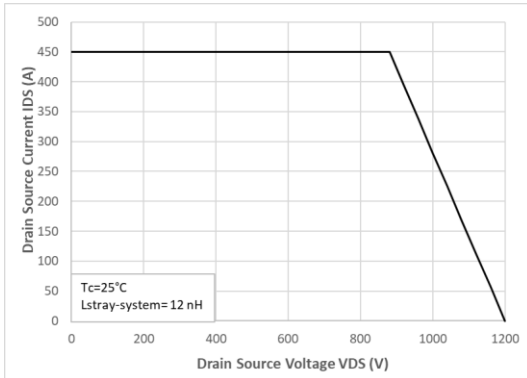
## Typical performances (per switch) (cnt'd)



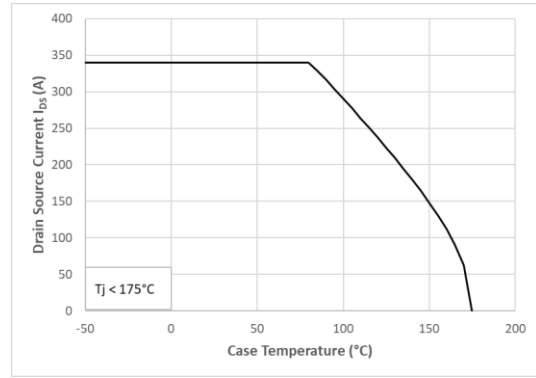
**Figure 15:** MOSFET Junction to Case Thermal Impedance



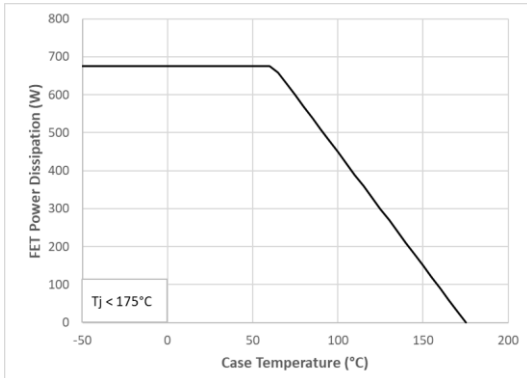
**Figure 16:** Forward Bias Safe Operating Area (FBSOA)



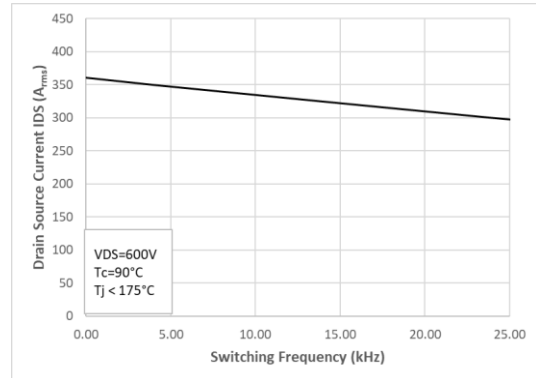
**Figure 17 :** Reverse Bias Safe Operating Area (RBSOA)



**Figure 18:** Continuous Drain Current Derating vs Case temperature



**Figure 19 :** Maximum Power Dissipation Derating vs Case temperature



**Figure 20 :** Typical Output Current Capability vs Switching Frequency (Inverter Application)

## Gate Driver Circuit Functionality

### Description

Main features of the CXT-PLA3SA12340A gate driver are:

- Isolated data transmission (robust to high dV/dt) (data and fault) on both high and low side channels
- Adjustable fault timer with automatic restart
- Safe start-up sequence through monitoring of the main supply (UVLO) and of the voltage regulators output (through Power-Good function)
- Permanent and programmable Under-Voltage Lockout (UVLO) monitoring on external and internally generated power switch supplies
- Desaturation detection function with programmable blanking time and threshold protecting power switches in case of abnormal current levels
- Soft-Shutdown transistor and control performing power device graceful shutdown in case of fault and so preventing too high di/dt in the power stage
- Flyback DC-DC converter (one per phase) with cycle-by-cycle current limit for short circuit protection
- High-precision (typ 3%) high-level gate voltage generation
- Single-ended Schmitt-trigger PWM inputs
- Open-drain low-ohmic (typ. 25Ω) fault output
- Support of 2 separate incoming PWM channels and of locally generated non-overlapped PWM signals (per phase) (configuration via jumper)
- Configurable 500ns (typ) spike filter on incoming PWM signal for enhanced noise robustness
- Anti-overlap protection on incoming PWM signals
- Gate-2-Source short-circuit protection
- Support of 100% duty-cycle PWM
- Very low parasitic capacitance between secondaries and primary

### Under-Voltage Lockout (UVLO)

CXT-PLA3SA12340A gate driver board monitors constantly:

- VCC power supply
- High-side secondary supplies (typ +15V/-3V)
- Low-side secondary supplies (typ +15V/-3V)

At primary side, the monitored power supply is "VCC-GND"; to avoid oscillation when (VCC-GND) is close to the UVLO threshold, a hysteresis is implemented.

At each secondary side, the monitored power supply is "VDD\_L-VSS\_L"/ "VDD\_H-VSS\_H"; to avoid oscillation when (VDD\_x-VSS\_x) is close to the UVLO threshold, a hysteresis is implemented.

Refer to the chapter Fault Management for details about fault behavior and management.

### On-board power supplies

The on-board isolated power supply (per phase) is a regulated flyback DC-DC converter providing both high-side and low-side channels with the positive and negative supply voltages required to drive the power FETs. It offers high voltage isolation between the channels, high dV/dt sustainability and very low parasitic capacitance. Cycle-by-cycle current monitoring at primary side is implemented to protect the board against short-circuit.

High accuracy (typ 3%) is achieved on all secondary positive supplies.

### Interface towards controller

#### PWM inputs

PWM-XB and PWM-XT input interface is based on 5V Schmitt-Trigger input receivers and is Active High. Active Low is available as an option.

CXT-PLA3SA12340A gate driver board implements 2 protection functions on the PWM data paths:

- Anti-glitch: any negative or positive glitch on PWM-XB/PMW-XT signals smaller than a programmed value is ignored by the board; this is increasing immunity of incoming signals against external noise; the PWM signals are delayed by the corresponding anti-glitch time

$$t_{\text{MINPW}} \text{ (ns)} = 1 * [C_{\text{GLIX}} \text{ (pF)}]$$

- Anti-overlap: this circuit prevents PWM-XB and PMWH from being active at the same time.

#### FAULT outputs

The output buffers operate as an open-drain driver with a very low Ron resistance (typ. 25Ω), enabling the use of low value pull-up resistance for increased noise immunity.

An on-board 10k pull-up resistance (connected to internal 5V supply) is present on each fault output to ease initial testing.

By default, there is one fault output per phase (one fault per side [top/bottom] is available as an option).

#### Isolated data transmission

CXT-PLA3SA12340A gate driver board uses integrated digital isolators. Those devices provide isolation, immunity against high dV/dt and low parasitic capacitance.

In case no power supply is present at the secondary side, a fault is generated at the primary side.

### Desaturation detection

The purpose of the desaturation function is to detect that the voltage at the drain of the power switch, in “ON” state, is higher than a given threshold. This informs the logic part of the system about possible damage of the power arm (e.g. a short circuit at the arm level leading to an overcurrent in the power switch).

The sensing of the power device drain voltage is performed through a high voltage sensing diode whom cathode is connected to the power switch drain and whom anode is connected to a current source (typ 2mA) and a sensing circuit.

The desaturation threshold (voltage on transistor VDS) is configured by on-board resistors and can be tuned according to the table below.

Rdesat value	Desat threshold (V)	
	25°C	125°C
0KΩ	1.18	1.47
5KΩ	2.6	2.87
10KΩ	4.01	4.27
12KΩ (default)	4.6	4.83
15KΩ	5.42	5.66
20KΩ	6.84	7.06

At system level, the de-saturation detection should only be taken into account after a defined time following the low-to-high transition on the power device gate. This “blanking” time  $t_{\text{DESAT\_D}}$  is implemented and adjusted by an on-board capacitor  $C_{\text{DESATD}}$  (68pF installed) and can be calculated as follows:

$$t_{\text{DESATD}} \text{ (ns)} = 14 * [C_{\text{DESATD}} \text{ (pF)} + 7]$$

If after  $t_{\text{DESAT\_D}}$  time, the DESAT comparator output indicates that the transistor VDS level is higher than the programmed threshold value, an internal DESAT fault is generated. Refer to the chapter Fault Management for details about fault behavior and management.

When the desaturation fault is detected, the power module gate is gracefully discharged thanks to the Soft-Shutdown circuit to avoid high di/dt at power module turn-off

### Active Miller Clamping

In case of high positive  $dV/dt$  and despite the negative drive of the power module gate, a parasitic turn-on of the gate could take place, inducing shoot-through current on the power arm.

To prevent this, CXT-PLA3SA12340A gate driver board implements an Active Miller Clamping function by bypassing the gate resistance with a low ohmic path (implemented with a transistor) when the gate is driven negative.

This transistor also helps to limit the amplitude of negative kick on the power module gate in case of negative  $dV/dt$ .

### Fault Management

Fault management is taking place on each phase independently.

At primary side, fault is generated by any of those situations:

- Main power supply (VCC) is below the UVLO threshold
- Primary linear voltage regulator (generating the 5V output required by the on-board logic) is below the internal Power Good level

Those faults are internally combined to generate a unique fault signal. This internal fault signal is latched for 14msec.

While the fault is latched:

- Both FLT-X pins are tied to "0"
- Both power switches are turned off
- On board DC-DC is off

After the predefined latch time period, the phase controller will attempt to return to normal operation:

- If the fault is still present, the phase will stay in the fault state till the fault disappears
- If the fault disappeared (e.g. temporary UVLO situation), the phase will go out of FAULT state and return to normal operation (DC-DC turned on and data paths active); still, on the PWM path, transition to normal operation will happen on the next positive edge of the incoming PWM signal.

The primary fault state is combined with the faults returned by the secondary devices according to Table 1.

Prim fault	Low-side fault	High-side fault	FLT-X
No	No	No	No fault
No	Yes	No	Fault
No	No	Yes	Fault
No	Yes	Yes	Fault
Yes	Yes or No	Yes or No	Fault

**Table 1: FAULT aggregation table**

At each of the secondary side, fault is generated by any of those situations:

- Power supply is below the UVLO threshold
- Secondary voltage regulator (5V) output voltage is below the Power-Good threshold
- Desaturation situation is detected by the DESAT comparator

Those faults are internally combined to generate a unique fault signal. This internal fault signal is latched for 14msec.

While the fault is latched, the gate driver is turned off. At the transition between "no fault" and "fault" situation, the gate driver circuit is gracefully shut down.

After the predefined latch time period, the gate driver circuit returns to normal operation:

- If the fault is still present, the gate driver is kept turned off till the fault disappears
- If the fault disappeared (e.g. temporary UVLO situation), normal operation will resume on the next positive edge of incoming PWM signal

### RSTN (Reset) behaviour

While in Low-State, pin RSTN forces all PWM input signals to "0", turning off all SiC MOSFET gates in Direct mode and turning off the High-Side SiC MOSFET and keeping Low-Side SiC MOSFET on in Local Mode

## Protections

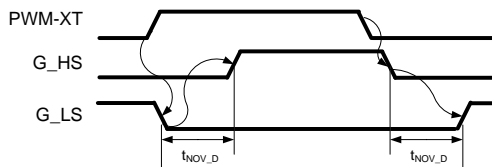
CXT-PLA3SA12340A gate driver is protected on each channel against:

- Gate overvoltage
- Gate undervoltage
- Gate-source permanent short-circuit

## Non-Overlap Generation

CXT-PLA3SA12340A gate driver board offers 2 modes of operation:

- Direct Mode: PWM-XB and PWM-XT are generated independently outside CXT-PLA3SA12340A gate driver board. In this case, proper non overlapping must be generated externally.
- Local Mode: PWM-XB and PWM-XT are generated from one input signal (PWM-XT) and proper non overlapping timing is managed locally on each phase of CXT-PLA3SA12340A gate driver board (cfr Figure 21)



**Figure 21: Local Mode operation**

The choice between those 2 modes of operation is made via the 2 pin header jumper JP1 (located at primary side, one per phase):

- JP1 ON: Local mode
- JP1 OFF: Direct mode

When in Local Mode, an on-board capacitance (C<sub>novd</sub>) defines the non-overlap delay according to following formula:

$$t_{NOV\_D} \text{ (ns)} = 5.5 * C_{NOVD} \text{ (pF)}$$

## Board power dissipation

Current consumption of the CXT-PLA3SA12340A gate driver board (VCC=15V; VDCX+=0V) can be computed as follows:

$$I_{in} = 167mA + 7 * Fs$$

Where:

- I<sub>in</sub>: Input current (in mA) (wrt to VCC = 15V)
- Fs: Switching frequency (in kHz)

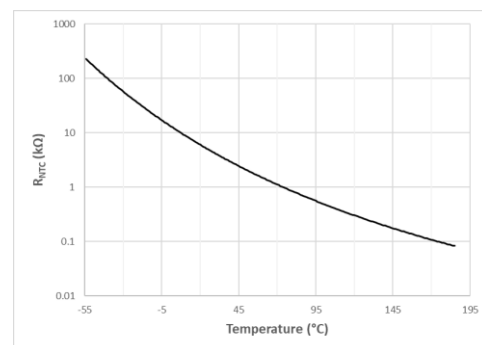
The duty cycle of the PWM-XB/PWM-XT signals has almost no influence on the current consumption (assuming PWM-XB and PWM-XT duty cycles are complementary).

To stay within specifications of the internal secondary voltages, the maximum average I<sub>in</sub> current should be 1000 mA (for VCC = 15V).

## Temperature measurement

Temperature of each phase is measured using an NTC resistance mounted on the power module DBC.

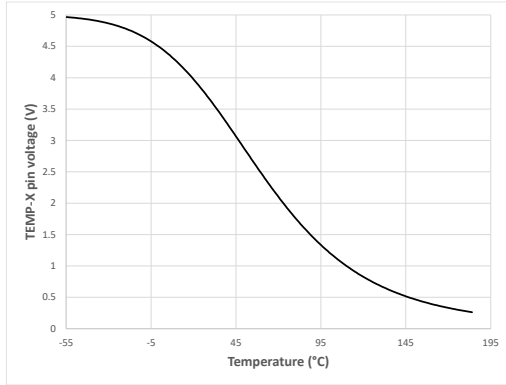
The NTC resistance variation with respect to temperature is reported in Figure 22: NTC resistance vs temp obeys to the formula provided in section Max Absolute Ratings.



**Figure 22: NTC resistance vs temp**



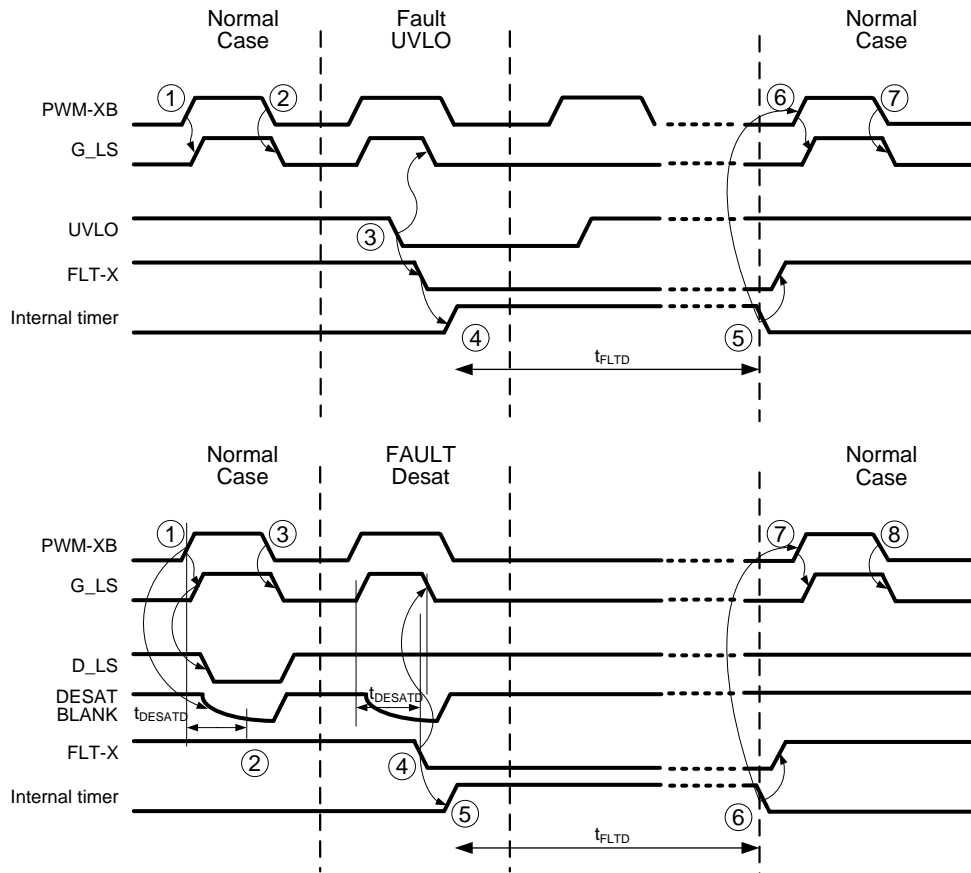
The NTC resistance value is converted into an analog voltage fed to the connector pins TEMP-U, TEMP-V, TEMP-W. Figure 23: TEMP-X voltage vs temp shows the relationship between TEMP-X voltage and NTC temperature.



**Figure 23:** TEMP-X voltage vs temp

## Timing Diagrams

Figure 24 illustrates the CXT-PLA3SA12340A gate driver board low-side driver dynamic behavior in normal operation and fault conditions.



**Figure 24: Timing diagram CXT-PLA3SA12340A low-side gate driver behaviour**

### In Normal operation

On PWM-XB rising edge (1), rising edge is generated on G\_LS (after propagation delay through CXT-PLA3SA12340A gate driver board).

After rising edge on G\_LS, low-side power module is turned ON and midpoint node is going to "0" state (voltage equals to  $R_{on} \cdot I$  current flowing through the power device). D\_LS node is also pulled down and after blanking time ( $t_{DESATD}$ ), no desaturation fault is detected and FAULTL remains high.

On PWM-XB falling edge (2), falling edge is generated on G\_LS (after propagation delay through CXT-PLA3SA12340A gate driver board)

After falling edge on G\_LS, the low-side power device is turned OFF.

### In DESAT fault situation

On PWM-XB rising edge (3), rising edge is generated on G\_LS (after propagation delay through CXT-PLA3SA12340A gate driver board)

After rising edge on G\_LS, low-side power module is turned ON; because of a desaturation fault, D\_LS node does not reach its normal "0" level. Thanks to the DESAT comparator, CXT-PLA3SA12340A gate driver board detects this fault situation and turns off gracefully G\_LS. Power device is turned off. FAULTL signal is pulled down. Fault is cleared after fault timer expiry.

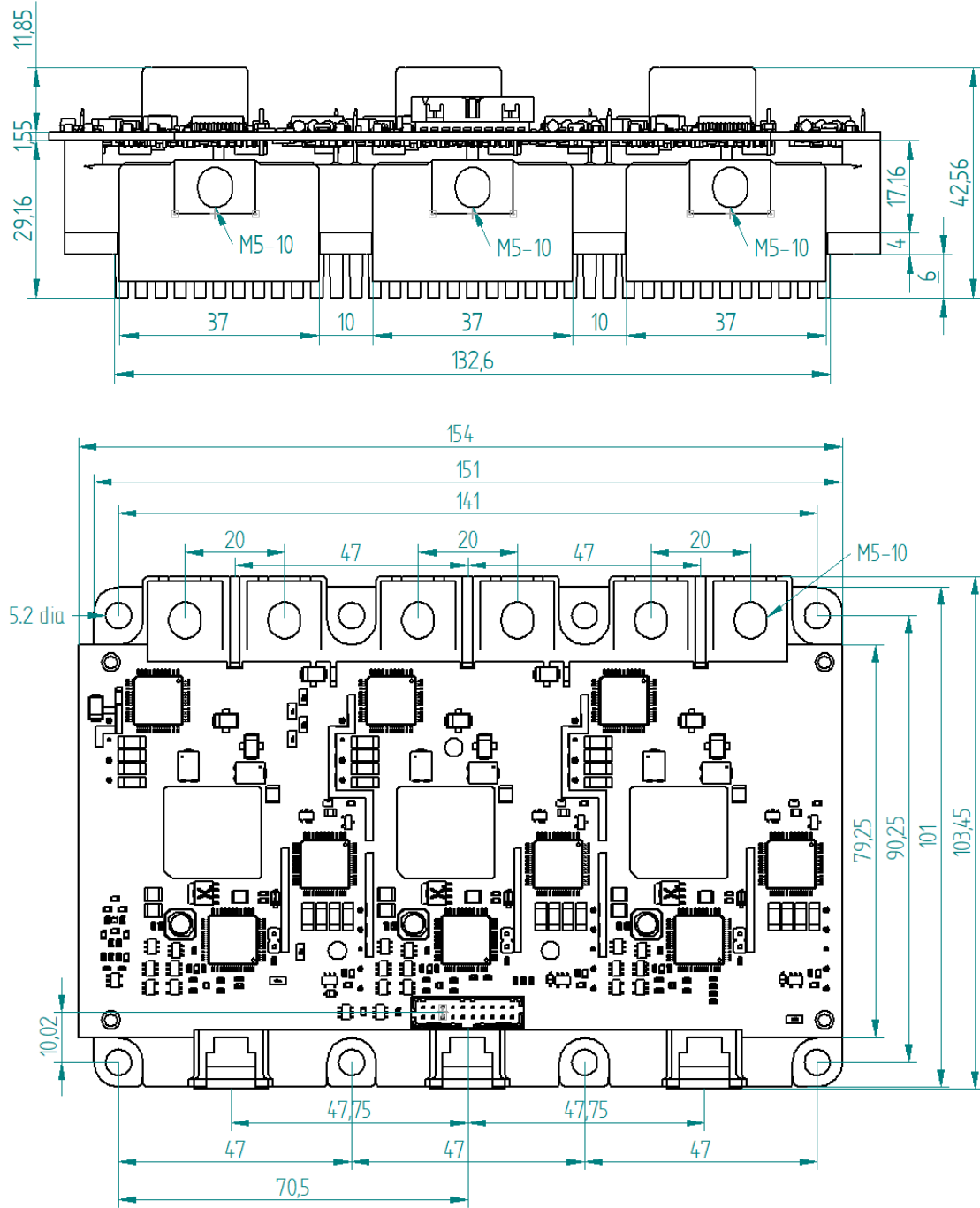
**In UVLO fault situation**

UVLO status is monitored inside the secondary devices (and inside primary device as well; for clarity, only secondary UVLO situation is described here). When UVLO comparator (5) detects an under-voltage situation, G\_LS is gracefully shut down FAULTL signal is pulled down. Fault is cleared after fault timer expiry.

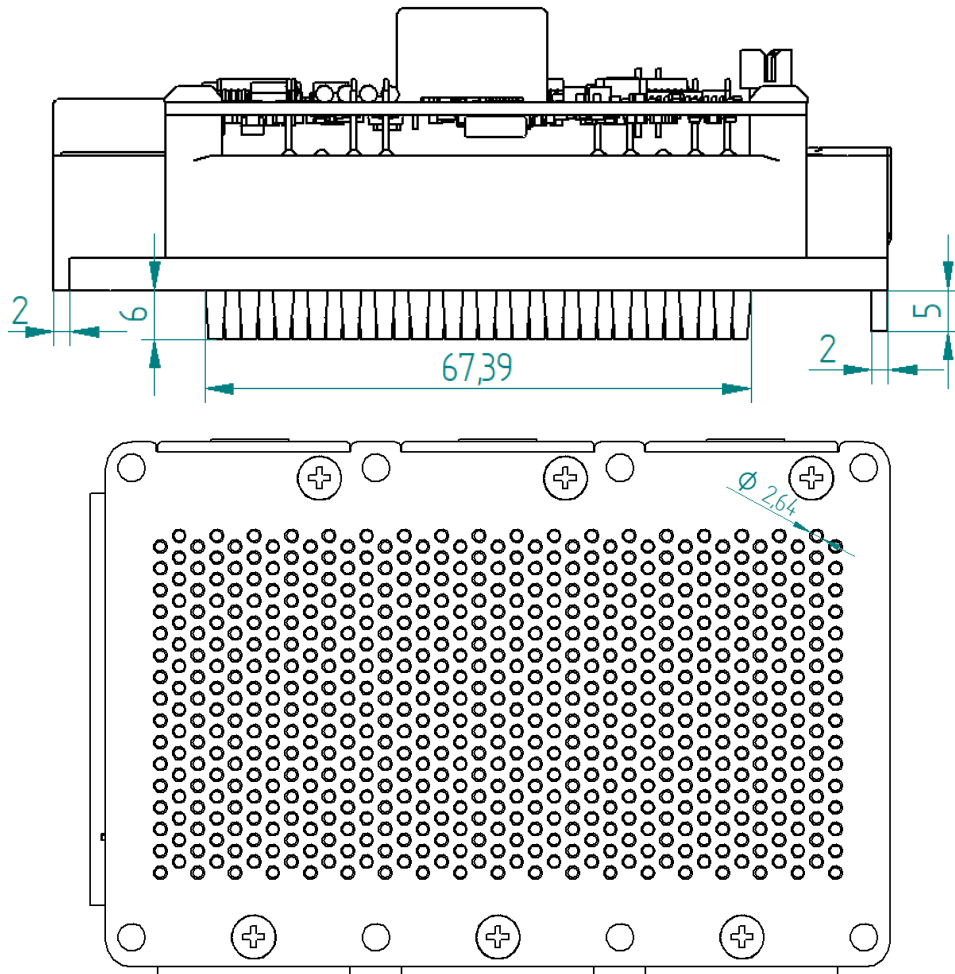
**Glossary**

Name	Description
D_HS	Drain of any high-side switch
S_HS	Source of any high-side switch
G_HS	Gate of any high-side switch
D_LS	Drain of any low-side switch
S_LS	Source of any low -side switch
G_LS	Gate of any low -side switch

**Mechanical drawing**



### 3-Phase 1200V/340A SiC MOSFET Intelligent Power Module Preliminary Datasheet



Physical dimensions (mm)  
 Base plate material: AlSiC  
 Power pins finish: Ni  
 Gate driver control pins finish: Au  
 Gate driver control connector: Molex 87831-2020

Item	Recommended reference	Comments
Baseplate fixing screws	M4x10 ISO 7380-2 A2 TX	
DC Bus Power connector bolts	M6x12 ISO 7380-2-A2-TX	Assumes min 0.7 mm DC power connector thickness
Phase power connector bolts	M6x12 ISO 7380-2-A2-TX	Assumes min 1.6 mm phase connector thickness
Gate driver female counter connector board-2-cable	Molex 51110 SERIES	
Gate driver female counter connector board-2-board	Molex 78787-2054(Tin) or 79107-7009(Gold).	

**Contact & Ordering****CISSOID S.A.**

<b>Headquarters and contact EMEA:</b>	CISSOID S.A. – Rue Francqui, 3 – 1435 Mont Saint Guibert - Belgium T : +32 10 48 92 10 – F : +32 10 88 98 75 Email : <a href="mailto:sales@cissoid.com">sales@cissoid.com</a>
<b>Sales Representatives:</b>	Visit our website: <a href="http://www.cissoid.com">http://www.cissoid.com</a>

**Disclaimer**

*Neither CISSOID, nor any of its directors, employees or affiliates make any representations or extend any warranties of any kind, either express or implied, including but not limited to warranties of merchantability, fitness for a particular purpose, and the absence of latent or other defects, whether or not discoverable. In no event shall CISSOID, its directors, employees and affiliates be liable for direct, indirect, special, incidental or consequential damages of any kind arising out of the use of its circuits and their documentation, even if they have been advised of the possibility of such a damage. The circuits are provided "as is". CISSOID has no obligation to provide maintenance, support, updates, or modifications.*