

5 A - 100 V power Schottky rectifier

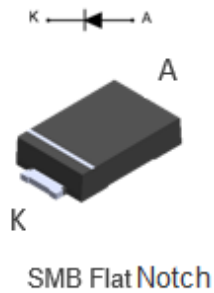

Features

- Low profile design – package height of 1.1 mm
- Wettable flanks for automatic visual inspection
- Low forward voltage drop
- Avalanche capability
- ECOPACK2 compliant

Applications

- Switching diode
- Notebook adapter
- LED lighting
- DC/DC converter

Description

This high voltage Schottky barrier rectifier has been optimized for use in high frequency miniature DC/DC converters, reverse battery protection, battery chargers and adaptors.

Packaged in SMB Flat Notch, the [STPS5H100UFN](#) provides a high level of performance in a compact and flat package which can withstand very high operating junction temperature.

Product status link

[STPS5H100UFN](#)

Product summary

Symbol	Value
$I_{F(AV)}$	5 A
V_{RRM}	100 V
T_j (max.)	175 °C
V_F (typ.)	0.545 V

1 Characteristics

Table 1. Absolute ratings (limiting values at 25 °C, unless otherwise specified)

Symbol	Parameter	Value	Unit
V _{RRM}	Repetitive peak reverse voltage	100	V
I _{F(AV)}	Average forward current, $\delta = 0.5$ square wave	T _L = 115 °C	A
I _{FSM}	Surge non repetitive forward current	t _p = 10 ms sinusoidal	A
P _{ARM}	Repetitive peak avalanche power	t _p = 10 μ s, T _j = 125 °C	W
T _{stg}	Storage temperature range	-65 to +175	°C
T _j	Maximum operating junction temperature ⁽¹⁾	+175	°C

1. $(dP_{tot}/dT_j) < (1/R_{th(j-a)})$ condition to avoid thermal runaway for a diode on its own heatsink.

Table 2. Thermal resistance parameters

Symbol	Parameter	Typ.	Unit
R _{th(j-l)}	Junction to lead	6.6	°C/W

For more information, please refer to the following application note:

- AN5088: Rectifiers thermal management, handling and mounting recommendations

Table 3. Static electrical characteristics

Symbol	Parameter	Test conditions	Min.	Typ.	Max.	Unit
I _R ⁽¹⁾	Reverse leakage current	T _j = 25 °C	V _R = V _{RRM}	-	8	μ A
		T _j = 125 °C		-	1.5	mA
V _F ⁽²⁾	Forward voltage drop	T _j = 25 °C	I _F = 2.5 A	-	0.640	V
		T _j = 125 °C		-	0.480	
		T _j = 25 °C	I _F = 5 A	-	0.745	
		T _j = 125 °C		-	0.545	

1. Pulse test: t_p = 5 ms, $\delta < 2\%$

2. Pulse test: t_p = 380 μ s, $\delta < 2\%$

To evaluate the conduction losses, use the following equation:

$$P = 0.470 \times I_{F(AV)} + 0.028 \times I_{F(RMS)}^2$$

For more information, please refer to the following application notes related to the power losses:

- AN604: Calculation of conduction losses in a power rectifier
- AN4021: Calculation of reverse losses in a power diode

1.1 Characteristics (curves)

Figure 1. Reverse leakage current versus reverse voltage applied (typical values)

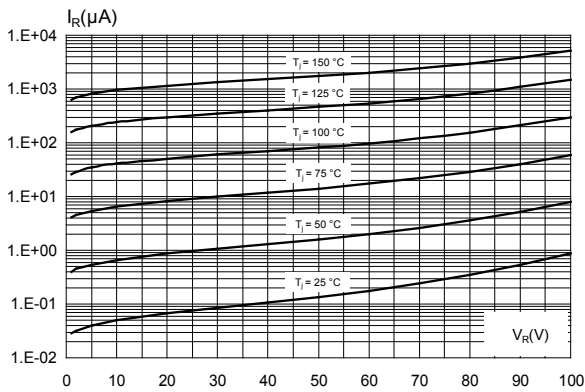

Figure 2. Junction capacitance versus reverse voltage applied (typical values)

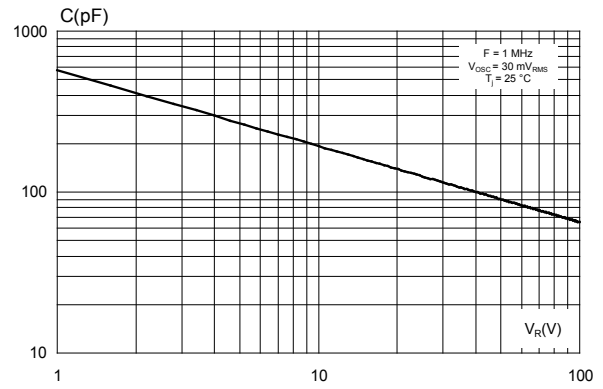

Figure 3. Forward voltage drop versus forward current (typical values)

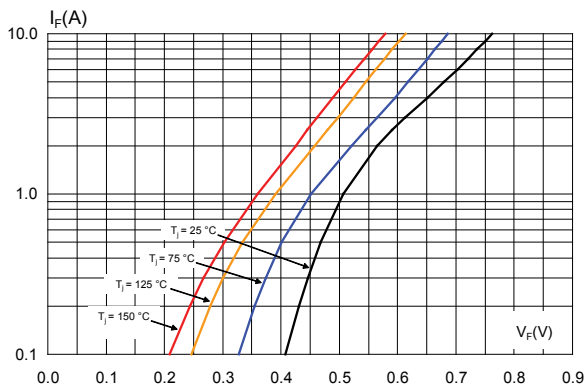

Figure 4. Normalized avalanche power derating versus pulse duration ($T_j = 125 \text{ °C}$)

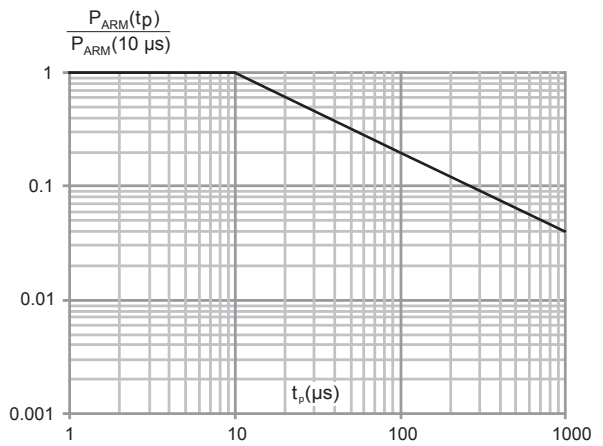
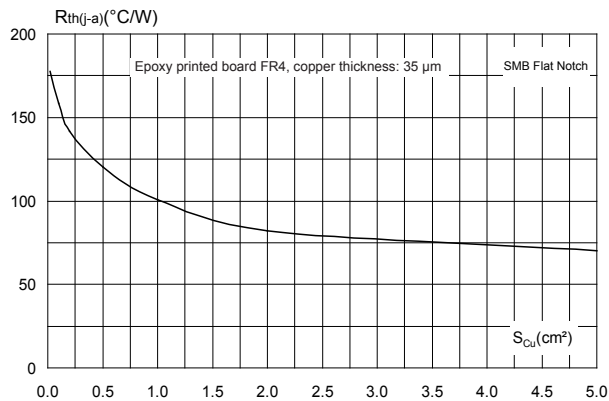

Figure 5. Thermal resistance junction to ambient versus copper surface under each lead (SMB Flat Notch)



2 Package information

In order to meet environmental requirements, ST offers these devices in different grades of **ECOPACK** packages, depending on their level of environmental compliance. ECOPACK specifications, grade definitions and product status are available at: www.st.com. ECOPACK is an ST trademark.

2.1 SMB Flat Notch package information

- Epoxy meets UL94, V0
- Lead-free package

Figure 6. SMB Flat Notch package outline

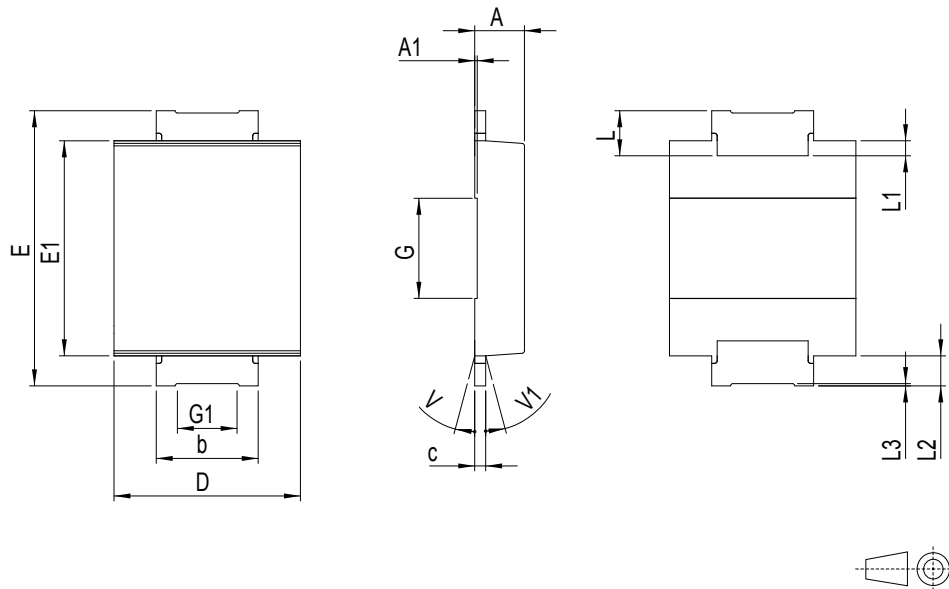
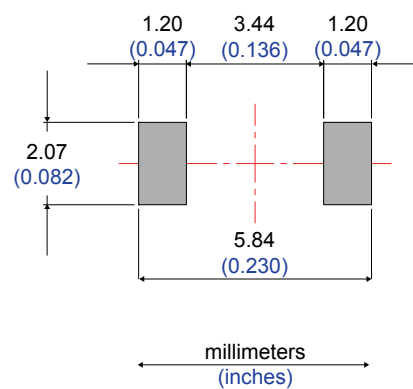

Table 4. SMB Flat Notch mechanical data

Ref.	Dimensions					
	Millimeters			Inches		
	Min.	Typ.	Max.	Min.	Typ.	Max.
A	0.90		1.10	0.035		0.043
A1		0.05			0.002	
b	1.95		2.20	0.077		0.087
c	0.15		0.40	0.006		0.016
D	3.30		3.95	0.130		0.156
E	5.20		5.60	0.205		0.220
E1	4.05		4.60	0.159		0.181
G		2.00			0.079	
G1		1.20			0.047	
L	0.75		1.20	0.030		0.047
L1		0.30			0.012	
L2		0.60			0.024	
L3	0.02			0.001		
V			8°			8°
V1			8°			8°

Figure 7. Footprint recommendations, dimensions in mm (inches)



3 Ordering information

Table 5. Ordering information

Order code	Marking	Package	Weight	Base qty.	Delivery mode
STPS5H100UFN	B51	SMB Flat Notch	0.056 g	5000	Tape and Reel

Revision history

Table 6. Document revision history

Date	Version	Changes
31-Jan-2020	1	Initial release.

IMPORTANT NOTICE – PLEASE READ CAREFULLY

STMicroelectronics NV and its subsidiaries (“ST”) reserve the right to make changes, corrections, enhancements, modifications, and improvements to ST products and/or to this document at any time without notice. Purchasers should obtain the latest relevant information on ST products before placing orders. ST products are sold pursuant to ST’s terms and conditions of sale in place at the time of order acknowledgement.

Purchasers are solely responsible for the choice, selection, and use of ST products and ST assumes no liability for application assistance or the design of Purchasers’ products.

No license, express or implied, to any intellectual property right is granted by ST herein.

Resale of ST products with provisions different from the information set forth herein shall void any warranty granted by ST for such product.

ST and the ST logo are trademarks of ST. For additional information about ST trademarks, please refer to www.st.com/trademarks. All other product or service names are the property of their respective owners.

Information in this document supersedes and replaces information previously supplied in any prior versions of this document.

© 2020 STMicroelectronics – All rights reserved